

HEWLETT-PACKARD JOURNAL

JUNE 1985

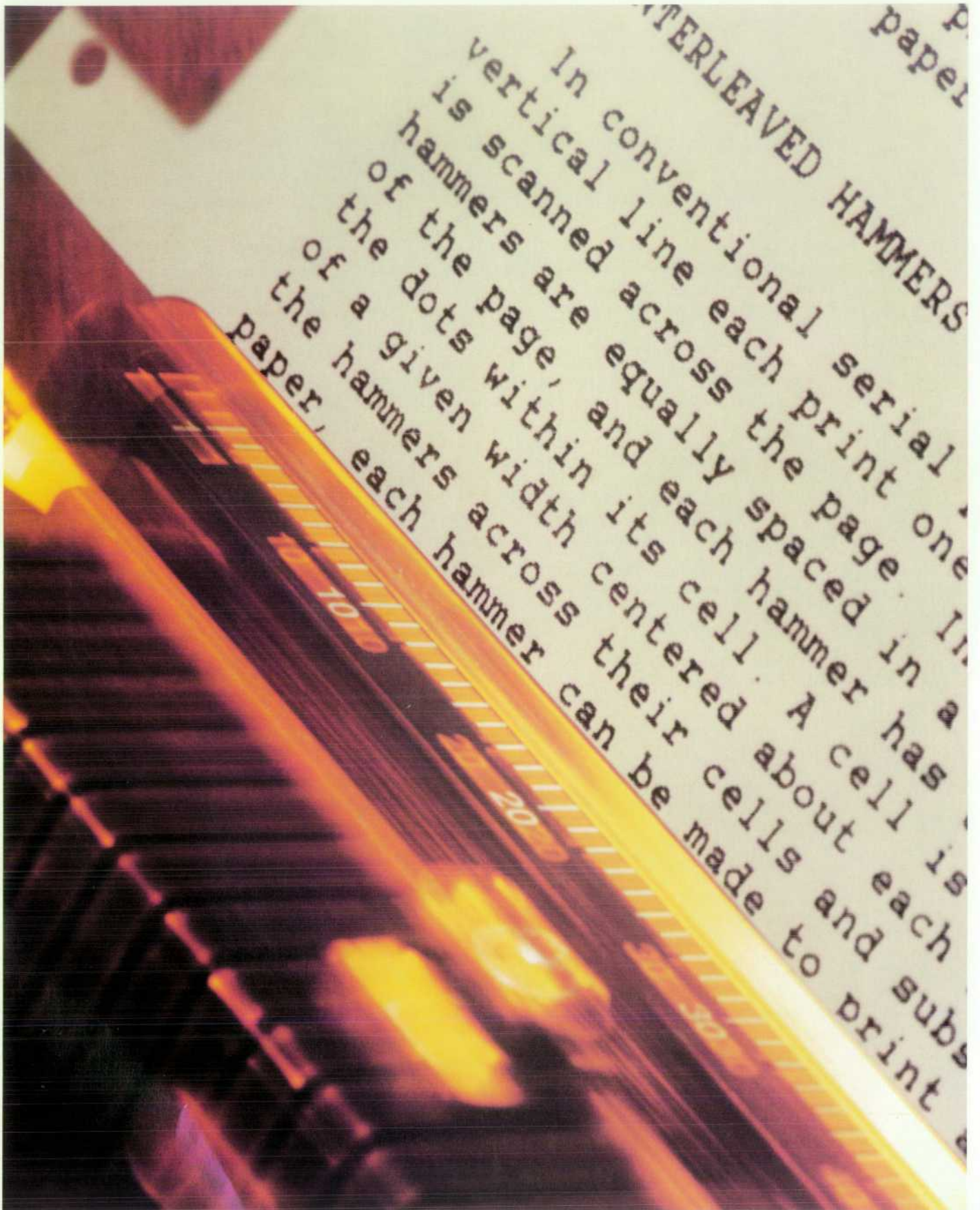

Articles

4 **A New Family of Dot Matrix Line Printers**, by Bryce E. Jeppsen *Low to moderate in cost, these heavy-duty printers are designed for EDP and manufacturing applications.*

5 **Design for Reliability in the HP 256X Family of Line Printers**

6 **Dot Matrix Printbar Design and Manufacturing**, by John S. Craven *The product of five years of development, the printbar offers excellent characteristics for print speeds from 300 to over 900 lines per minute.*

9 **Shuttle System and Packaging of a Low-Cost, High-Reliability, 300-lpm Line Printer**, by Jeffrey M. Lantz and Ben B. Tyson *Simplicity and reliability were the overriding design requirements.*

13 **Mechanical Design of a Family of High-Speed Impact Line Printers**, by George V. McIlvaine, Stephen L. Testardi, Daniel D. Wheeler, and Peter Gysling *Dot placement accuracy must be maintained with the printbar oscillating at 60 Hz and the paper moving at 900 lpm.*

15 **Computer Modeling of a Paper Drive Mechanism**

17 **Resonance Search Technique**

18 **Cost-Effective, Versatile Line Printer Electronics and Firmware**, by Philip Gordon, Phillip R. Luque, and Donald K. Wadley *Here's the nerve center that does the formatting, sequencing, controlling, and communicating.*

20 **Vector Graphics for Dot Matrix Printers**

23 **Printer Command Language Provides Feature Set Standard for HP Printers**, by Ernest F. Covelli, Von L. Hansen, and David L. Price *Now applications written for one HP printer won't have to be rewritten to run on another.*

25 **Authors**

27 **Native Language Support for Computer Systems**, by Jonathan E. Bale and Harry E. Kellogg *Software localization is easier if the operating system provides the right facilities.*

30 **Native Language Collating Sequences for Europe**

In this Issue



In the early days, computer output came from a line printer on oversize fanfold computer paper. Today there are alternatives, but if you look at any large computer you'll probably still find a line printer attached, spitting out the same fanfold computer paper at a rate that causes concern about the adequacy of our tree farms. Of the several kinds of line printers available, those that offer the most flexibility and generally better and more consistent print quality are the dot matrix impact line printers. Characters are printed as dot patterns, each dot produced by striking the paper through an inked ribbon with a hammer or a printwire. These printers have been available with print speeds up to 600 132-character lines per minute. Starting on page 4, most of the articles in this issue deal with the design of a new family of dot matrix impact line printers that extends this performance to 900 lines per minute with greatly improved reliability and lower cost. The family consists of a low-cost 300-line-per-minute model and two heavy-duty models that print at 600 and 900 lines per minute, respectively. The key element in the performance of these printers is a new printbar, shown in action on the cover and described in the article on page 6. This printbar has one hammer for each character position (each four positions in the low-cost model). When a hammer strikes the paper it makes one dot. To enable each hammer to print entire characters, the printbar is imbedded in a resonant mechanical system and oscillates rapidly from side to side. It's not hard to imagine the engineering challenges here—a new printbar with precise characteristics, (page 6), highly predictable resonant mechanical systems (pages 9 and 13), and high-speed electronics to fire the hammers at precisely the right times as the printbar reciprocates rapidly back and forth in front of the paper (page 18). Print quality is excellent; graphics and bar codes hardly look as if they're composed of dots at all (see page 20). Another advanced feature is described in the article on page 23. It's a new command language that will permit not only these new line printers but all new HP printers to speak the same language.

In today's international marketplace, software localization is an important concern (see our September 1984 issue). The problem is to make computer applications software such as a word processing program easily translatable into languages other than the language in which it was written. This has to be addressed in the design of the software packages, but as the article on page 27 explains, it's much easier on the application designer if the system software—the operating system and utilities—provides features for this purpose. On the HP 3000, HP 1000, and HP 150 Computers, these features are now standard and are called Native Language Support. Fourteen languages are supported, including Japanese Katakana.

-R. P. Dolan

What's Ahead

Four articles in the July issue will be devoted to the design stories of the HP 4951A and HP 4953A Protocol Analyzers. Protocol analyzers are used for checking the data transmitted between elements of a computer network. These two are suitable for field service and computer center applications. A fifth article will describe PC-10, the process control system module of HP's Semiconductor Productivity Network.

A New Family of Dot Matrix Line Printers

These impact printers are designed for EDP and manufacturing applications. Speeds available are 300, 600, and 900 lines per minute.

by Bryce E. Jeppsen

HEWLETT-PACKARD'S NEW FAMILY of dot matrix impact line printers not only offers several significant advantages over similar products currently available, but also makes substantial contributions to HP's total system offering. These printers, called the HP 2563A, HP 2565A, and HP 2566A, Fig. 1, operate at print speeds of 300, 600, and 900 lines per minute (lpm), respectively. They are targeted for electronic data processing and distributed manufacturing applications.

Four key objectives of the development program were to minimize customer costs, significantly improve operating reliability, extend the performance of dot matrix line printer technology, and standardize the system and human interfaces among members of the family.

Minimizing cost was particularly important for the HP 2563A Printer because of the extreme competitiveness in the low-cost end of the market. Regular project reviews were facilitated by modeling the product costs, employing the same process used in production to track the cost of manufactured products. Constant attention by engineers helped minimize parts count and assembly time. Custom

VLSI technology, simplified mechanism design, and advanced comprehensive packaging design made a substantial difference. Even after the printers were released for volume production, cost reduction efforts continued as new ideas were generated.

Perhaps the most difficult objective to grasp and implement was increased reliability. The HP 2608A/S Line Printer, which was to be replaced, had established a well-deserved reputation as the most reliable printer in its class. The objective for the new printers was to improve its failure rate by a factor of four! The road to meeting this objective included very careful design, thorough testing, and hard work. Exhaustive design reviews, the use of HP preferred parts, and over six months of strife testing in addition to environmental, regulatory, life, and system conformance testing characterized the effort (see box, page 5). The HP 2563A, after less than two years of production, has achieved its goal. We expect the data will show a similar accomplishment for the newer HP 2565/6A as these products mature.

Perhaps the most noticeable achievement of these new line printers is the performance standard they set. Many



Fig. 1. The HP 2563A (foreground), HP 2565A, and HP 2566A Line Printers are dot matrix impact printers that operate at speeds of 300, 600, and 900 lines per minute, respectively. High reliability and print quality and low cost of ownership were primary design objectives.

Design for Reliability in the HP 256X Family of Line Printers

Throughout the design and development phases of the HP 256X Line Printers, reliability was a key focus. A commitment was made by the project teams to design in reliability and to follow through with equal emphasis on reliability in the manufacturing process. Among the special efforts directed to this end were: (1) leveraging from earlier reliable product designs where possible, (2) using design reviews for new and unproven designs, (3) committing to a test-fix-test approach to proving designs, (4) using a burn-in program for early production units, and (5) choosing participants for the production engineering team from among the strongest design team members.

The test-fix-test and burn-in programs received special attention and emphasis from the R&D, manufacturing, and product assurance departments. Each required a substantial commitment of time, material, and equipment resources, and represented dedication to a philosophy expressed by David Packard in July 1972, when he stated, "Reliability cannot be achieved by adhering to detailed specifications. Reliability cannot be achieved by formula or analysis. Some of these may help to some extent but there is only one road to reliability. Build it, test it, and fix the things that go wrong. Repeat the process until the desired reliability is achieved."

The test process that demanded the largest commitment of resources and was most effective in exposing reliability concerns during the development phases was strife testing—subjecting a product under development to simultaneous stress and life test conditions and focusing attention on failures that occur. Stress was achieved by operating at extremes of ambient temperature, applied voltage, and applied frequency, and by cycling these parameters between extremes. The strife test cycle is shown in Fig. 1.

The criterion for successful completion of strife testing was at least 12 consecutive cycles with no hard failures. Hard failures are those that would require a customer to call a service person to return the product to an operating condition. Soft failures, on the other hand, are those that require only operator intervention for correction. The concern with these was their frequency of occurrence under normal operating conditions.

Soft failures were addressed in another battery of tests referred to as media tests, in which large volumes of paper were run through the printers. Data was collected on the frequency of failures, and iterative design improvements continued until goals were achieved. Samples of print output from these tests were also collected on a regular basis and examined in detail for print quality.

A third battery of tests was directed exclusively at life testing. The biggest concern was printbar life. Life of the printbar was measured in terms of the number of impacts the hammers could undergo before a failure would occur. These tests began with early prototype machines and continued throughout the development and early production phases. The failure mode of most concern was wear on the hammer-pole impact surface to the

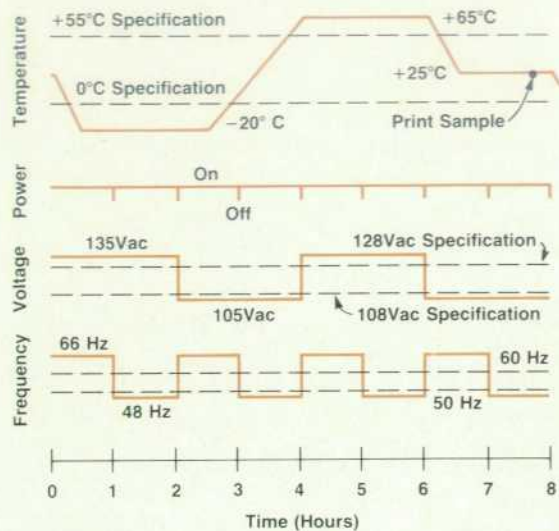

Fig. 1. The strife test cycle for HP 2563/5/6A Line Printers.

point where the hammer would no longer be captured against the pole face. The design goal was 2×10^9 impacts and the testing of a recent printbar was stopped at 3×10^9 impacts without failure.

Although the combination of strife, media, and life testing was central to achieving the aggressive reliability goals for the HP 256X printer family, additional testing was needed during the production ramp-up. Items of concern were (1) second-tier design-related problems that may have escaped detection in the R&D lab because of the statistically small number of units tested in the development phases, (2) vendor-related problems that begin to surface as large quantities of parts appear, and (3) workmanship-related problems that surface as newly trained employees become involved in the production ramp-up. To address these concerns, it was decided that burn-in testing would be used for all units. As in development, temperature and power cycling were used to attempt to accelerate failure mechanisms. During the early production periods, each unit was subjected to 30 complete cycles of burn-in. Failures that occurred were cataloged, prioritized, and addressed in priority sequence. With effective and intense action on the problems, component and workmanship problems have been eliminated to a point where it has been possible to reduce the burn-in cycling to only five cycles per unit. This final screening is intended to discover any problems that may arise as a result of changes in the design or a vendor's manufacturing process.

Everett M. Baily
Reliability Engineer
Boise Division

line printers are based upon a full font print mechanism, which means that each impact prints a full character. Such printers frequently use a band technology and range in speed from 300 to 3000 lines per minute, but have the drawbacks of poor reliability, limited flexibility, and often

poor print quality. Dot matrix printers, which offer much greater flexibility, multiple font styles and sizes, graphics and barcodes, and generally better and more consistent print quality, have been previously limited to 600 lpm performance. The introduction of the 900-lpm HP 2566A

has broken this barrier, offering a performance level previously not attained by a dot matrix impact line printer. The key component in this achievement is a new printbar, a product of five years of development.

Paper motion control at these performance levels is an extremely difficult task and represents a second major design contribution. A third contribution is the method of formatting text and symbols and generating and sequencing the corresponding dot images while concurrently controlling the real-time mechanical operations and communicating with the host computer system.

A final objective was to solve a problem that has plagued

the industry, namely that printers developed by HP and others are designed with features that differ from printer to printer. Individual printers often require special system instructions which are intended to optimize the use of the printer's capabilities. Therefore, applications written for one printer usually have to be modified to work correctly on another printer. The HP Printer Command Language was developed to solve this dilemma. This protocol is used by all members of the new printer family.

The articles on the following pages tell in detail how the design objectives were met in the HP 256X family of line printers.

Dot Matrix Printbar Design and Manufacturing

A new captured-hammer printbar system meets performance needs from 300 to 900 lines per minute.

by John S. Craven

THE IDEAL DOT MATRIX PRINTBAR prints dots in precise locations, at high speed, with high energy. It consumes very little power. It is reliable under all operating conditions, prints on a wide range of paper stock, and is inexpensive.

In practice, the design of a printbar is a compromise among many of these requirements. For example, low input energy per dot and high print energy at the paper conflict. This article tells how these compromises were made in the design of the printbar for the HP 256X family of line printers to provide excellent characteristics for print speeds from 300 to 900 lines per minute.

Design Fundamentals

The actuator is a force-balance system; magnetic forces are balanced against hammer spring forces. Control of the magnetic forces results in the impact of the hammer with the ribbon to print a dot.

The system (Fig. 1) consists of a permanent magnetic circuit adjacent to a hammer. The hammer is mounted on a surface ground at a slight angle (exaggerated in Fig. 1) such that the spring section is deflected by the magnetic force until the hammer is captured against the magnetic pole faces. As the magnetic force is neutralized by passing current through the coils, the hammer is thrown toward the paper by the spring force. The energy available for printing dots is determined by the stiffness of the hammer spring and the distance the hammer is cocked by the magnetic circuit. The cocking distance is the focal point of the design.

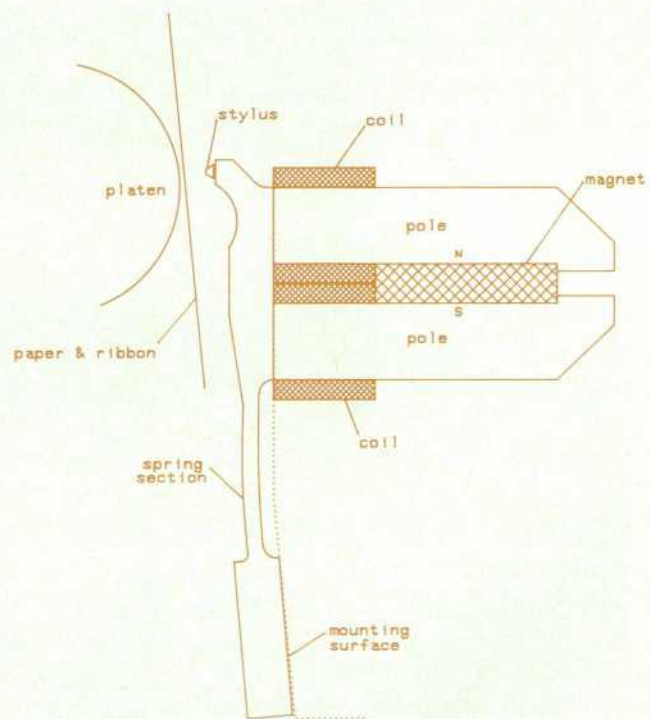

Fig. 1. Hammer actuator system of the HP 2563/5/6A Line Printers.

The force balance theory can be plotted as shown in Fig. 2. The gap between the hammer and the magnetic pole faces is on the horizontal (X) axis and the absolute value of force, either magnetic or mechanical, is on the vertical (Y) axis. The integral of force times distance is energy, represented by the area under each curve.

The inclined straight line describes the hammer spring characteristic. At zero force, the relaxed hammer rests at the cocking distance from the pole surface (X intercept). The force proportional to the deflection is highest when the hammer is fully cocked (Y intercept). The second curve is the nonlinear force imposed on the hammer by the magnetic circuit as a function of the gap between them. The magnetic force never reaches zero as the gap opens, and is limited by the flux capacity of the magnetic circuit when the hammer is cocked. The magnetic force acts in opposition to the spring force, but is shown inverted here for easy comparison. The relationship shown is a desirable one—the magnetic force is greater than the spring force at all hammer positions. This guarantees that between current pulses, the hammer is stable and will return to the cocked position.

The motion of a hammer is determined by the net force imposed on it. As the magnetic force becomes greater or less than the spring force, the hammer responds either towards or away from the magnet poles. To release the hammer, coil current is increased to drop the magnetic force curve. If the release margin is small (spring force is nearly equal to magnetic force), very little current will be required, but the system will be very sensitive to manufacturing tolerances and wear. Such variations might cause the magnetic force curve (with zero current) to cross the spring force curve, creating a second stable hammer position at the intersection of the curves. This condition is termed bistability, and is considered a failure, since hammer capture cannot be guaranteed. If the release margin is large, current and heat dissipation demands will be high,

but manufacturing and wear tolerances are greater.

To maximize efficiency, the number of coil turns is maximized while the coil resistance is minimized. The resolution of this trade-off requires maximizing the copper volume per actuator. Coils are wound in perfect layers to fill the available volume. The wire size is determined by a compromise between efficiency and speed. Large wire with few turns is faster (lower inductance), but generates larger eddy currents in the poles. The coil is most efficient when matched to the hammer speed.

The drive pulse is shaped to maximize hammer frequency. Current rises quickly, then remains high until the hammer is far enough from the magnet poles to avoid slowing it down. While the hammer is printing the dot, the current is reduced by a flyback circuit, allowing the magnetic force to increase, aiding the hammer's rebound from the ribbon, paper, and platen.

To ensure uniform dots, spring energy is maximized by increasing cocking distance (X intercept of the spring force line in Fig. 2) or spring stiffness (slope of the spring force line). Forms thickness, manufacturing tolerance, and wear life considerations favor a larger cocking distance, while hammer speed considerations favor a stiffer spring with a shorter stroke. In either case, the spring energy limit is imposed by stability, as discussed above. To obtain energy beyond the stability limit, the magnetic force curve must be raised by increasing the magnet strength or by improving the magnetic circuit efficiency to allow the spring force line to be raised.

This technology is being used in a number of product applications. The following parameter ranges are delivered in production:

Hammer frequency	up to 2.2 kHz
Drive energy per dot	7 to 15 millijoules
Print gap	up to 0.41 mm
Print force	7 to 20 newtons
Print energy	1 millijoule

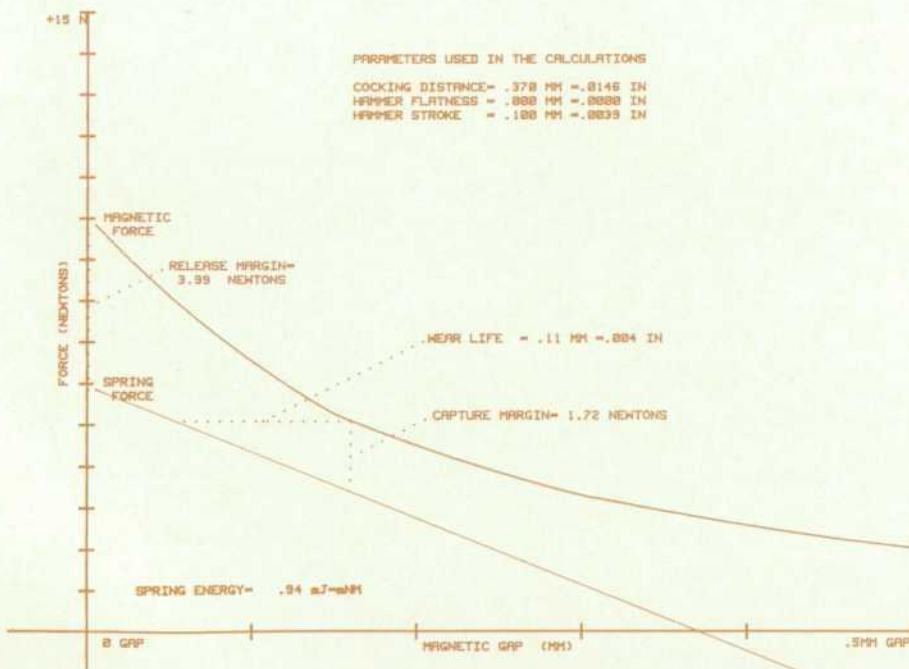

Fig. 2. Under quiescent conditions, the printing hammers are held against the magnet faces because the magnet force exceeds the hammer spring force. To print a dot, the magnet force is neutralized and the hammer is thrown towards the paper by the spring force.

Fabrication

The printbar is modular: coil modules form corebar modules which, with a casting, form the corebar. The addition of hammer modules completes the printbar.

Corebar Module. Compactness in the coil module decreases magnetic flux leakage and increases the reliability of the coil connections. A laser soldering system terminates the very short leads of the coils on a flexible printed circuit without overheating the coils. Though it takes up little space, the flexible circuit provides electrical isolation from the poles and magnets, while the heavy copper in the circuit helps dissipate the locally generated heat.

Bobbinless coils ensure high heat transfer to the poles, but are susceptible to short circuits because the bare wire can touch the poles. Isolation from the poles is provided by molding the module over core pins shaped to form ridges of plastic along the inside of each coil. The poles are shaped to touch only the ridges, and not the exposed coil wire. Both the coils and the poles are rigidly constrained without touching by the ridges and by a high-thermal-conductivity adhesive less than 0.1 mm thick between them.

Corebar Assembly. After assembly of coil modules, poles, and rare-earth magnets into the casting, the front surface of the corebar is ground to precise form. The shape of the corebar surface, which determines the cocking distance, is generated by a diamond roll, which shapes the grinding wheel.

Hammer Modules. Each module of 11 hammers is cut from a flat steel block in a broaching operation. First the large surfaces are shaped to generate the cross sections for the springs and heads, and then the individual hammers are separated by cutting through the blank. The precision of these operations determines the stiffness, flatness, and fatigue life of the hammers. The hammer modules are ground and lapped to generate the mounting interface so critical to uniform cocking distance. An automated drilling machine forms countersinks in the hammer heads, which receive carbide balls in an automated ball-welding machine. The balls are ground into pyramidal styli by a grooved grinding wheel, which finishes all the styli on a hammer module in two passes.

Printbar Assembly. The styli must be positioned within 0.05 mm in two dimensions. The HP 2563A printbar has a single row of 33 styli, so the alignment is simple. The HP 2565/6A Printers, however, have two interleaved rows of 66 styli each, which must align when they impact the paper. Therefore, the styli are intentionally misaligned when cocked to allow for the curvature of their flight paths.

Testing

The flatness and stiffness of the hammer are measured together in a special fixture. The hammer module is held by its mounting surface to mimic functional mounting. Noncontacting capacitance probes are used to measure the hammer positions before and after a known mass is lowered onto the hammer at the predicted center of magnetic force. The kinematics of the hammer/spring system are calculated from the measured data.

Corebar surface geometry is measured by an automated, self-calibrating test system, which scans the surface of each corebar with multiple sensors to determine the profiles of

the intersecting planes. The system calculates the angles between surfaces and their points of intersection along the length of the corebar. The resolution is 0.25 micrometers, so the slightest deviations from nominal can be detected and displayed graphically for immediate feedback to the grinding operator.

The hammer and corebar surface data allow production operators to control the spring force line (Fig. 2).

Although bare magnets are sample tested accurately, in-corebar testing is sometimes necessary to determine the cause of performance changes. When the coil in an actuator is driven to produce a zero flux reading in a special sensor above the pole surface, the effects of the poles and their interface with the sensor become negligible. Thus, we can get an indication of the strength of the magnet independent of the poles by measuring the current required to null the flux. With the magnet strength known, the performance of the poles alone can be implied from a measurement of the flux without current. This indicates, for example, whether the case hardening of the poles was done correctly.

System Performance

The interactions of the individual tolerances are evaluated by an automated test system. This 100% production test drives the print actuators and measures position and coil current to reconstruct the theoretical curves (Fig. 2).

Printbars are tested indirectly for only the critical points of the curves: the release point, the capture point, and the cocking distance (see Fig. 3). The test system gradually increases current through the coil under test, lowering the magnet force curve until the hammer releases. This release current is an indication of the energy required to fire the hammer. The test system continues to increase the current until the hammer reverses direction because of magnet flux reversal. The maximum hammer excursion indicates the cocking distance. Then the current is decreased, raising the magnet force curve, until the hammer suddenly jumps

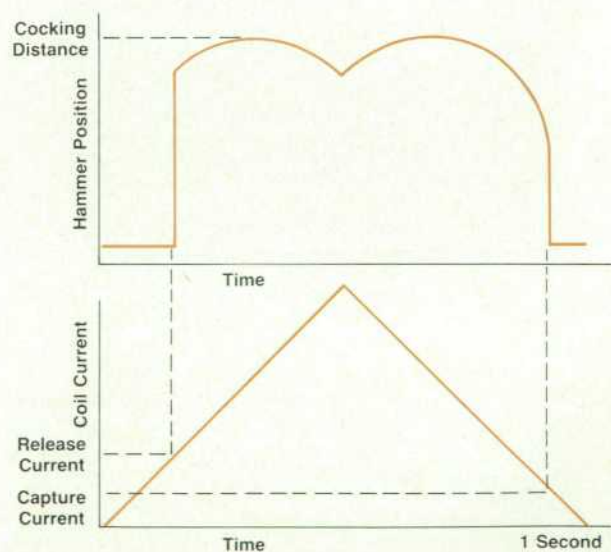

Fig. 3. Hammer position and magnet coil current during testing of a hammer for release current, cocking distance, and capture current.

toward the magnet poles. The current at that point is the capture current.

The capture current is significant because it indicates not only the present state of the actuator, but also its potential life. As a print actuator wears, metal is removed and the cocking distance increases. The spring force curve shifts toward the right (Fig. 2) and the force margin decreases. Extensive testing has shown that, by a combination of non-linear effects, the capture current is a linear function of normal wear. After a break-in period, the life of a test bar can be predicted far in advance of actual failure. Data from such life tests was used to determine the minimum allowable capture current for production printbars to assure a life of at least 2×10^9 dots.

Conclusion

The modularity, size, efficiency, and speed of the actuator make it adaptable to a wide range of applications. This printbar technology has been incorporated in all mem-

bers of the HP 256X Printer family. It is used to print text and graphics on paper stock ranging from single-part paper to six-part forms and heavy labels. The fabrication parameters can be adjusted to obtain a range of combinations of speed, print force, life, and print gap.

Acknowledgments

The actuator design is the product of a team of design and process engineers headed by project leader Bill Robison. Carl Geleyne developed the stylus weld system. Ralph Tenbrink was responsible for hammer and pole process development and metallurgy. Horst Lechelt was the grinding expert for corebars and hammers, and developed the fixturing along with Charley Ewert. Charley also developed the corebar profile test system. Warren Keller was involved in the final debugging of the coil module process. Dale Grooms designed fixtures and printbar details and assisted with life tests.

Shuttle System and Packaging of a Low-Cost, High-Reliability, 300-lpm Line Printer

by Jeffrey M. Lantz and Ben B. Tyson

IN DOT MATRIX LINE PRINTERS, the printing device (the printbar) oscillates horizontally with a frequency and displacement determined by the throughput requirements, the number of hammers used, and the number of dot rows in the character cell. Designing an oscillatory shuttle mechanism for such a printer presents interesting problems in dynamics and stress analysis. In the case of the HP 2563A Printer, stringent requirements of simplicity and reliability guided the design of the shuttle mechanism. The printing process requires the printbar to oscillate at a frequency of 18 Hz. Oscillation of the printbar with a sinusoidal velocity profile was chosen because this type of motion is easy to obtain using a spring mass system. Operating in a resonant condition minimizes the power required to drive the shuttle system. Along with the reduction in power comes a reduction in the shuttle driving forces, which increases the reliability of the mechanism.

The printbar shuttle mechanism (Fig. 1) consists of two masses (the printbar and counterweight), their mounting flexures (E-flexures for the printbar and standard flexures for the counterweight), and the electromechanical drive (dc motor, crankshaft, and flexible connecting rods).

The shuttle mechanism operates at resonance with the printbar and counterweight inertial forces canceling each other. While the printbar resonant system could work without the counterweight, forces caused by the accelerating printbar would be transmitted to the stand or tabletop and

would be unmanageable. The addition of the counterweight, also driven at resonance but 180 degrees out of phase with the printbar, balances the inertial forces of the printbar (Fig. 2). A small inertial moment is generated, however, because the centers of mass of the printbar and counterweight are not precisely in line.

Flexure Stresses Determine Size

The counterweight has twice the mass and oscillates at one half the displacement of the printbar. This proves necessary because space constraints allow counterweight flexures of only 108-mm length. With this length and a counterweight displacement equal to the printbar's, the stress in the flexure would have been too high for a target life of 10^8 cycles. The equation defining the counterweight flexure stress as a function of mass is:

$$\sigma_2/\sigma_1 = n^{-2/3}$$

where n is the ratio of the counterweight mass to the printbar mass, σ_1 is the stress for $n = 1$, and σ_2 is the stress for a mass ratio of n .

This equation assumes a resonant counterweight, with the displacement of the counterweight equal to the displacement of the printbar divided by n . From Fig. 3, it can be seen that the flexure stress for $n = 2$ is 63% of the stress for $n = 1$.

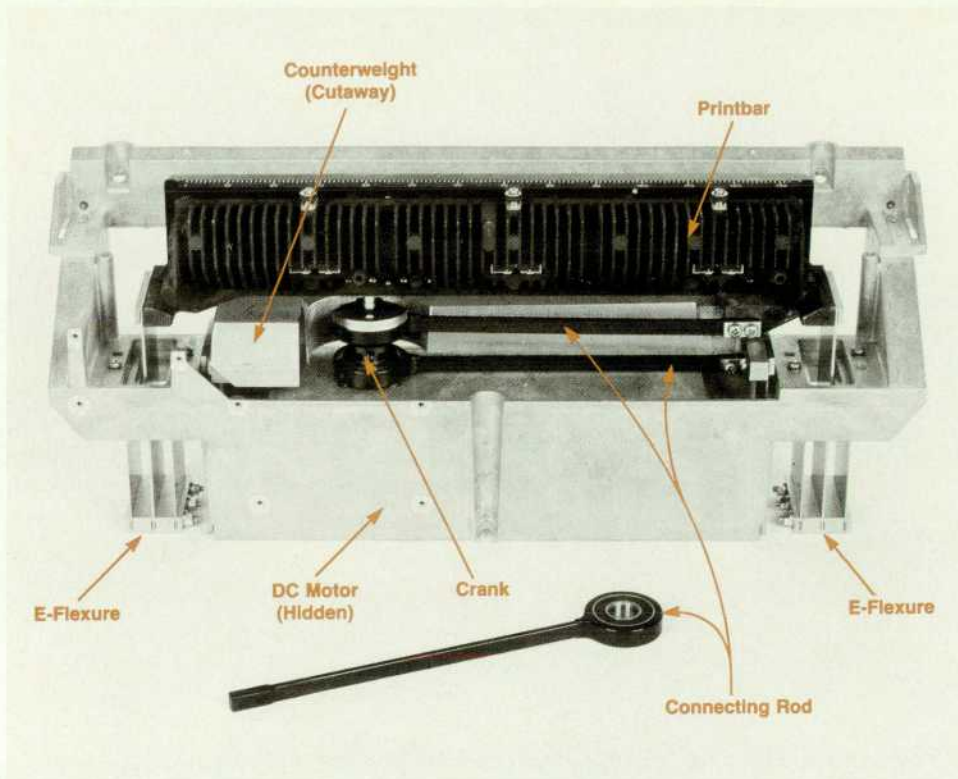

Fig. 1. The shuttle mechanism of the HP 2563A Line Printer consists of the printbar and counterweight, their mounting flexures, and the electromechanical drive. Flexible connecting rods connect the crankshaft to the printbar and counterweight. To keep the cost low, the connecting rod material is molded around the ball bearing.

A mass ratio of 2 was chosen because that is where the stress in the counterweight flexures equals the stress in the E-flexures. Also, the density of the Zn-Al alloy used for the counterweight created a mass ratio limit near 2 because of the volume available.

E-Flexure Design

The printing process requires a printbar displacement of ±5.0 mm. This displacement introduced the problem of crowning: as a flexure is displaced, its effective length is shortened (Fig. 4). Crowning can be approximated by:

$$\Delta y = \frac{1}{2} \int_0^l (dy/dx)^2 dx = 0.6 \frac{y^2}{l}$$

In this equation, dy/dx is the slope of the deflected flexure curve, l is the flexure length, and y is the flexure deflection. For a displacement of 5 mm, the crowning would have been 0.13 mm with a standard flexure (Fig. 4). This amount of crowning is nearly one half the vertical dot spacing used

in forming the characters. The effect would have been seen as scalloping of the horizontal lines. The E-flexures reduce the crowning because the short and long flexures nearly cancel each others' effects. The short flexures raise the printbar and the long flexure lowers it (see Figs. 5 and 6).

Flexible Connecting Rods

Flexible connecting rods are used to connect the crankshaft to the printbar and counterweight. This ap-

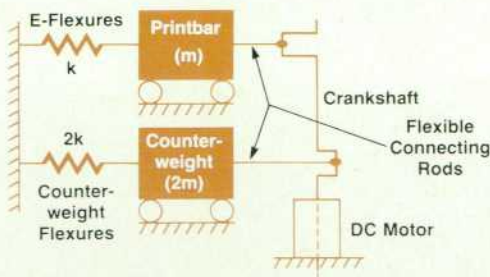

Fig. 2. Mechanical schematic diagram of the shuttle mechanism.

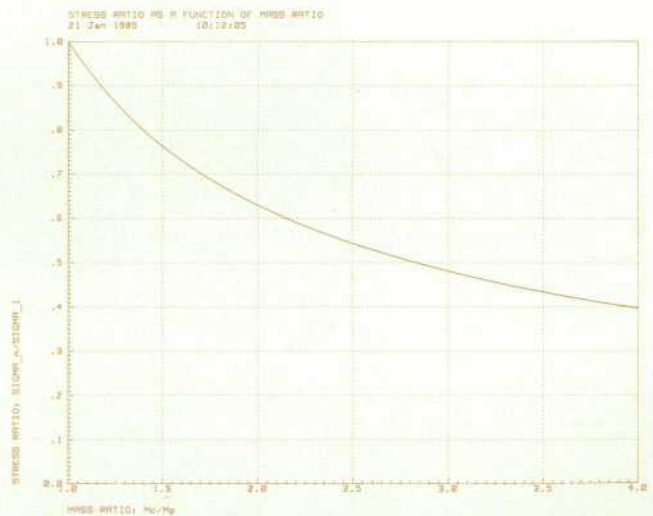

Fig. 3. Stress ratio versus ratio of counterweight mass to printbar mass. Stress ratio is the stress in the counterweight flexures for a given mass ratio divided by the stress for a mass ratio of one.

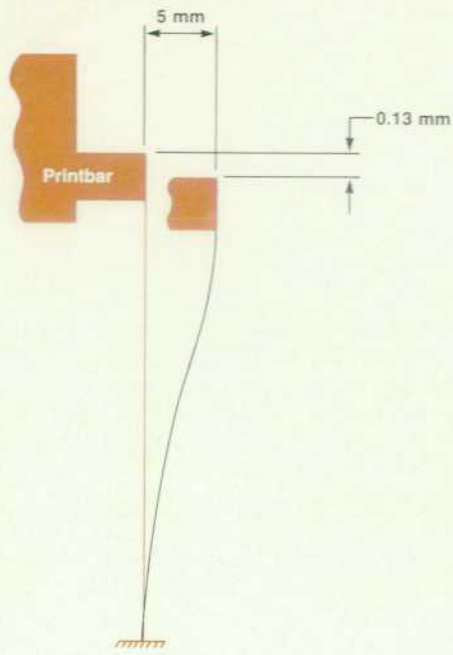

Fig. 4. Crowning of a flexure: as the flexure is displaced, its effective length is shortened.

proach simplifies the design by requiring only two bearings instead of four. The connecting rod material is molded around the ball bearing to keep costs low. The bearing is placed in the molding tool and glass-filled nylon is injected around it. As the plastic cools, it shrinks to constrain the bearing tightly (Fig. 1). The bearing and the flexible connecting rod can now be pressed onto the crankshaft.

Startup Algorithm

During printing, torque and motor current are kept low

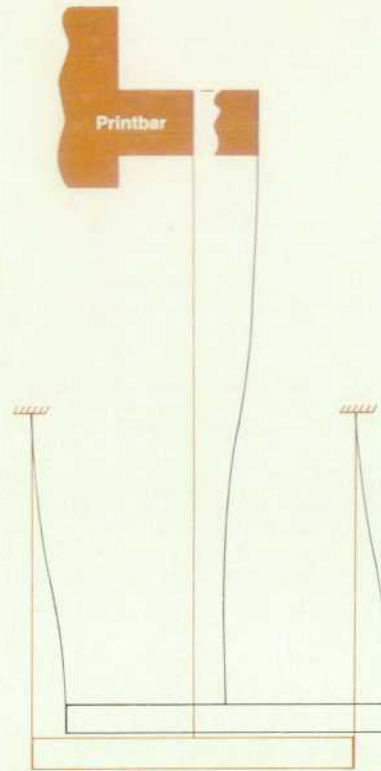

Fig. 5. E-flexures reduce crowning. The short flexures raise the printbar and the long flexure lowers it, and the effects tend to cancel.

because of the resonant system. Only 10 watts of power is required to drive the shuttle system. However, the startup torque required is much greater than the running torque. To keep the motor small and the electrical drive inexpensive, a special algorithm is used to start the mechanism



Fig. 6. Crowning of standard and E-flexures.

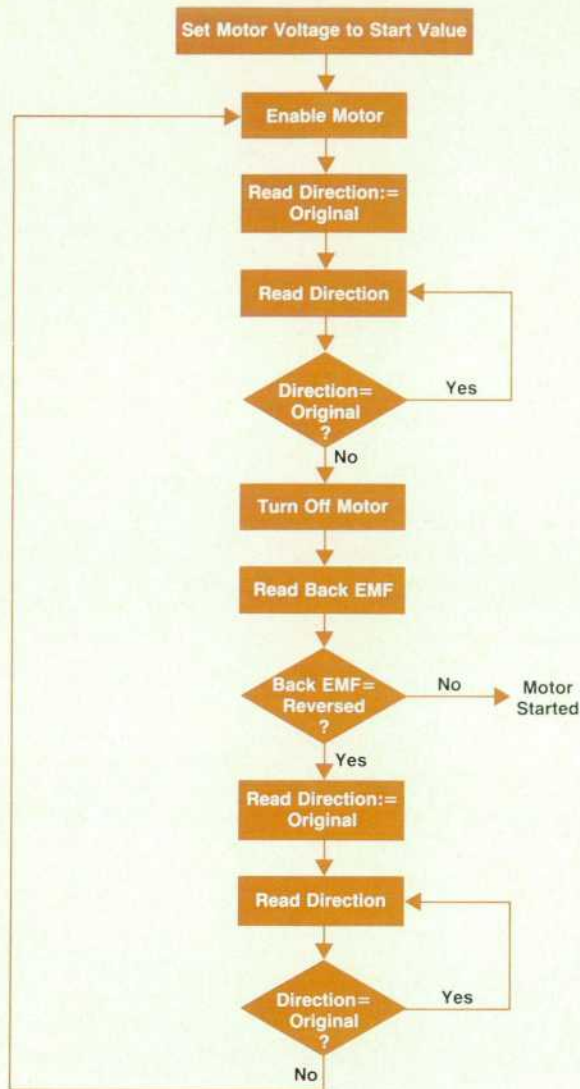

Fig. 7. This starting algorithm allows the use of a smaller motor.

(Fig. 7). Implemented in control processor firmware, the algorithm can turn the motor on and off and set the voltage supplied to the motor. The firmware requires two bits of information: a printbar direction signal from the encoder and the sign of the back EMF from the motor. The encoder determines the direction of the printbar motion. The sign of the back EMF indicates whether the motor is turning clockwise or counterclockwise.

The firmware initially turns on the motor and senses when the direction changes. The first direction change will occur because the motor cannot overcome the static torque, so the shuttle system, which has started to move, begins to return to a static equilibrium condition. As soon as the direction changes, the motor is turned off and the back EMF read to see if the motor is rotating in the same direction or has reversed. If the rotation has reversed, the firmware waits for one more direction change and then turns on the motor again. This process of pumping more energy into the system continues until the back EMF indicates that the

motor is rotating continuously in the same direction and not reversing itself. This startup procedure takes approximately 100 ms.

Packaging

The cabinet for the HP 2563A Printer has to make the printer quiet while providing necessary openings for ventilation and paper input and output. When the printer is used on a tabletop, the paper enters through a slot in the lower front. When used on the enclosed stand, an alternate paper path is provided through the bottom, allowing the front slot to be sealed off acoustically. The paper exits the back of the printer to move the noise source farther from the operator. Possible acoustic leaks between the main cover and the access cover are sealed with a gasketed tongue-and-groove detail. The print mechanism is isolated as much as possible from the electronics (where the heat vents are located) to prevent noise generated by the printing process from escaping the package. An impeller is added to the rotor of the ribbon drive motor to provide the cooling needed in the print mechanism.

Structural foam was chosen for the cabinet material because of its strength and acoustic properties. Structural foam gave us the ability to mold in fine details like keepers for the draw catches, card guides, and cable routing clips. The structural integrity of the foam is particularly important, since the hinge/gas-spring mount detail is molded into the covers. The main cover and the access cover have the hinge pins and holes molded in, eliminating the need for a separate hinge and associated mounting hardware. The gas spring serves to keep the access cover from slamming closed and prevents its being raised to a position that would allow it to be removed.

The operator panel, which is shared by all 256X Printers, uses a silicone rubber keypad. Electrical connection is made when the conductive pads attached to the bottoms of the keys contact the serpentine traces on the underlying printed circuit board. A thin membrane at the bottom of each key provides the snap action. The bezel is molded in a conductive plastic for electrostatic protection.

The top-level assembly time is minimized since the print mechanism mounts with only three screws, the major electronic parts snap or slide into the base, and the fan is sandwiched in place when the cover is installed.

Acknowledgments

Much credit should be given to Tom Baker. His influence on the mechanical design of this product cannot be overstated. Ken Wade and Bill Weiser designed the startup algorithm. Other contributors to the mechanical design include Bob Cort, John Huffman, and Brian Picht.

Mechanical Design of a Family of High-Speed Impact Line Printers

by George V. McIlvaine, Stephen L. Testardi, Daniel D. Wheeler, and Peter Gysling

IMPACT PRINTERS generally have more moving parts than other peripheral devices, and the HP 2565A (600 lpm), and HP 2566A (900 lpm) are no exceptions. They are also some of the physically largest products that Hewlett-Packard offers.

The HP 2565/6A Printers move paper at high speed past a bank of 132 interleaved hammers which are mounted on a resonant reciprocating printbar. A towel ribbon carrying ink passes between the paper and the styli, which are attached to the hammers.

Interleaved Hammers

In conventional serial printers, printwires arranged in a vertical line each print one horizontal dot row as the print-head is scanned across the page. In a dot matrix line printer, the hammers are equally spaced in a horizontal line across the width of the page, and each hammer has the function of printing all of the dots within its cell. A cell is defined as a vertical band of a given width centered about each hammer. By reciprocating the hammers across their cells and subsequently advancing the paper, each hammer can be made to print an entire character. When the cell width is equal to the hammer spacing, a dot can be placed anywhere on the page. Fig. 1 compares the formation of the character A by a serial printer and a dot matrix line printer.

The speed of a dot matrix line printer is limited by both the number of hammers and the maximum rate at which they can be actuated. Many dot matrix line printers use from 33 to 66 hammers to print a standard 13.2-inch-wide page, but their speeds have been limited to 600 lines per minute (lpm). To achieve print speeds of up to 900 lpm, the HP 2565/6A Printers use printbars with 132 hammers spaced on 0.1-inch centers. The hammer design requires a minimum horizontal spacing of 0.2 inch, but by interleaving an upper and a lower row of hammers, an effective 0.1-inch spacing is achieved (Fig. 2).

Resonant Printbar Dynamics

One of the primary mechanical requirements of the HP 2565/6A Printers is a means of reciprocating the printbar so that each hammer can print anywhere within its cell. This must be done while maintaining a constant hammer-to-platen gap within ± 0.01 mm. Reciprocating a printbar becomes more difficult as the mass of the bar and the frequency and amplitude of reciprocation increase. For the HP 2566A to print at 900 lines per minute with graphics capability, it is necessary to reciprocate a 3-kg printbar at 60 Hz, with peak-to-peak amplitudes of at least 0.1 inch.

The method chosen to accomplish this is shown in Fig. 2. The printbar is mounted on a pair of leaf springs or flexures. A linear motor is mounted on four flexures beside the printbar. The flexures constrain the printbar and motor

to move in a nearly parallel relationship with each other and the print mechanism. The driving force is applied to the system through the linear motor, which consists of a magnet with an annular air gap. A cylindrical motor coil (much like the voice coil of a loudspeaker) is attached to the printbar and extends into the air gap. Current flow through the coil exerts equal and opposite forces on the motor and the printbar.

The thicknesses of the flexures are selected so that both the printbar and linear motor are resonant at the proper frequency. Because of the high spring rates involved, extremely high forces would be required to drive the system at anything other than its resonant frequency. (A static force of 541 newtons would be required to displace the printbar to the outermost bound of a character cell!) To minimize drive power requirements, the system is driven at resonance, with the printbar and linear motor moving colinearly and 180 degrees out of phase. If the linear motor is tuned to exactly the same frequency as the printbar, the resultant force transmitted to the print mechanism is

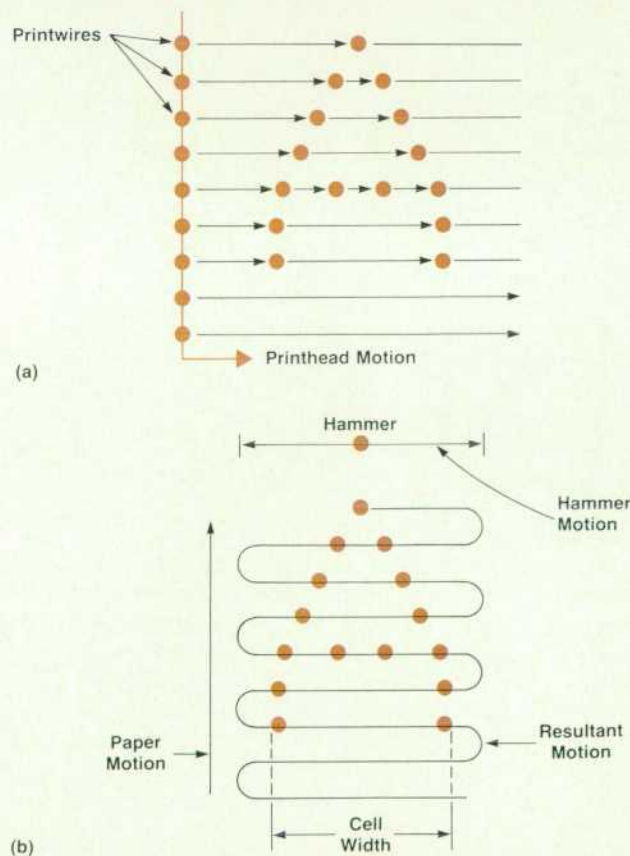

Fig. 1. Formation of the character A by a serial printer (a) and a dot matrix line printer (b).

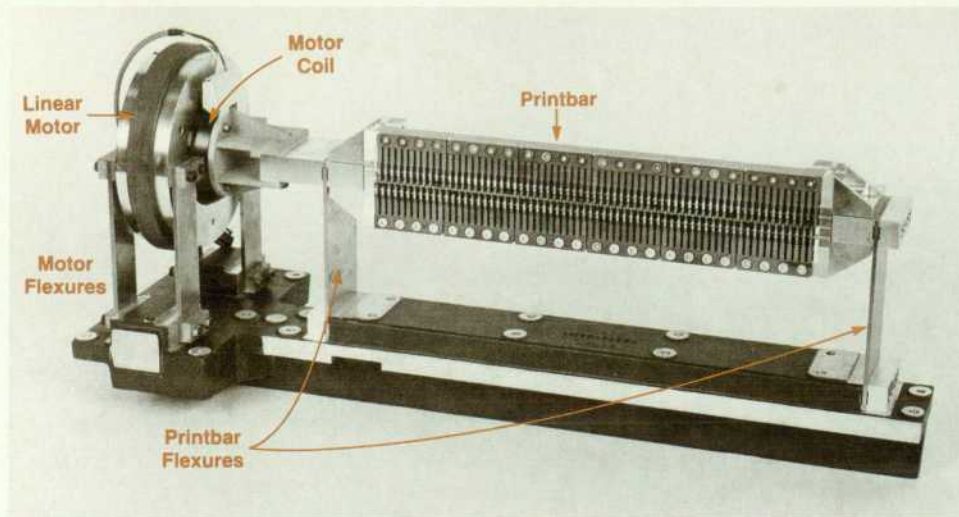

Fig. 2. The HP 2565/6A printbars have 132 hammers spaced on 0.1-inch centers. Upper and lower rows of 66 hammers each are interleaved.

theoretically zero. To allow for real-world variations, the print mechanism is mounted on compliant bushings to isolate it from the printer frame. Because of the sharp resonant peak of the mechanical system, a resonance search technique is employed by the control processor at power-on or reset to ensure that the system is always driven at resonance regardless of minor changes or variations in physical parameters (see box, page 17).

The system is controlled by a velocity feedback loop. A velocity transducer between the printbar and the print mechanism provides a feedback signal, which is summed with a digitally generated control signal to yield a velocity error. This signal is compensated slightly to avoid high-frequency instability problems and then fed to the linear motor amplifier. Printbar position information is provided to the printer control processor by integrating the velocity transducer output.

The advantages of such a drive scheme are numerous. There are no wear points that require lubrication and the life of the mechanism is essentially infinite with no periodic maintenance required. The power requirements and weight are less than those of a cam-follower system. The amplitude of reciprocation can be adjusted programmatically to optimize printer performance, and an entire family of printers can be leveraged by changing the thickness of the printbar and motor flexures to yield different resonant frequencies for different-speed printers.

Towel Ribbon Control and Correction

Although towel ribbons have been used in impact printers for many years, the HP 2565/6A Printers are the first Hewlett-Packard-designed printers that use them. All earlier HP designs use ribbon cartridges, which deploy a thin band instead of broad spools of inked nylon.

Control systems for towel ribbons are well-documented and will not be explained here. However, during development of these printers, a problem arose with bunching and wrinkling of the towel ribbon near the print area. Small wrinkles would propagate through the ribbon web, branching and merging to form larger wrinkles, which eventually became a tight localized foldover of ribbon on the take-up spool. Uncorrected, the foldover would increase in severity

until protective electronic circuits turned the mechanism off. Many solutions, including changes to the circuits limiting the ribbon drive motor torque, additional ribbon position sensors, and fundamental ribbon control system restructuring were proposed. These electronic solutions, however, did not address the underlying cause of the problem, which was the formation of wrinkles in the ribbon web. Eventually, a simple mechanical change completely solved the problem.

(continued on page 17)

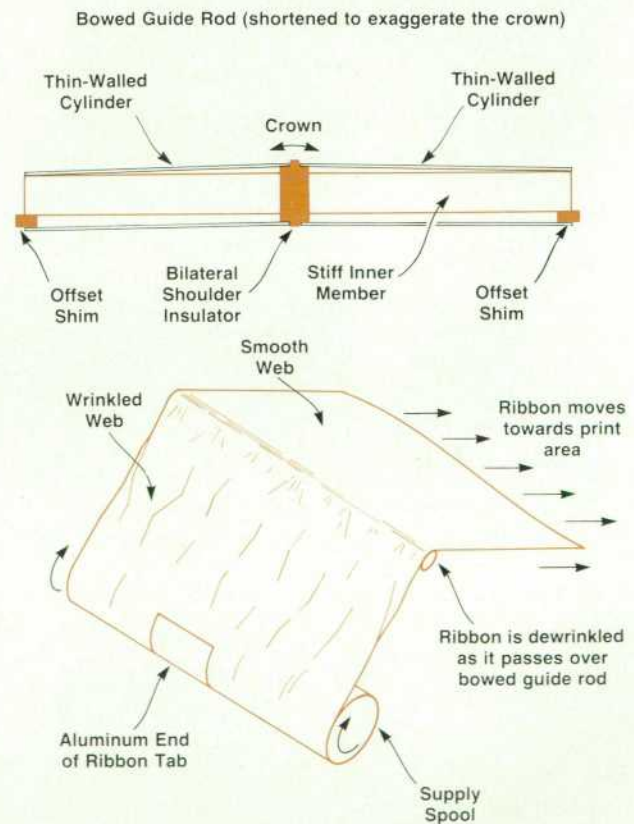

Fig. 3. The towel ribbon is dewrinkled as it passes over a bowed guide rod.

Computer Modeling of a Paper Drive Mechanism

In the HP 2565/6A Line Printers, the paper is advanced while the printbar is changing direction. Based upon the desired print speed, the fastest expected hammer speed, and the dynamic limitations of the paper drive system, the time available to step the paper is 4 ms. A step motor was chosen to drive the paper feed tractors because of its accuracy and its adaptability to reliable open-loop control. The torque of a step motor varies with the position of the rotor and the current in the windings. The torque-versus-position relationship is a series of sinusoidal curves (Fig. 1). The motor is stepped by switching from one torque curve to another. The printer firmware does this by turning the windings of the motor on and off and changing the current to the windings.

In doing a full step, the motor will overshoot the desired step by about 90% of a step and then oscillate about the desired

position until it finally comes to rest. This ringing effect is characteristic of step motors and needs to be damped to achieve proper paper motion. There are several ways to do this, but one method is by giving the motor two half-steps rather than one full step. The currents and the timing of the two half-steps are selected so that the motor increments one full step very quickly without any ringing.

Step current, hold current, and delay-to-hold are the three parameters that make up a step sequence. The step current and the hold current determine the peak value of the sinusoidal step torque and the hold torque curves. The delay-to-hold is the time between the start of the first half-step and the start of the second half-step.

A computer model of the dynamics of the paper drive system was developed and compared with the actual printer. The model

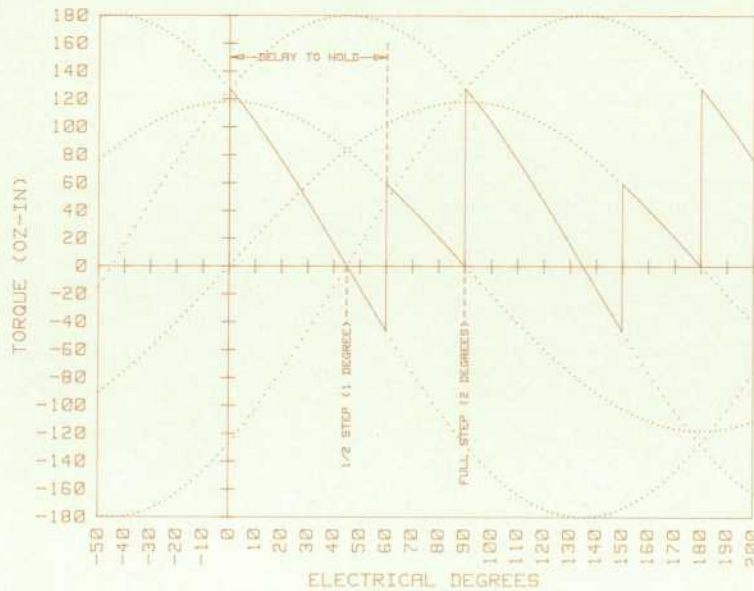
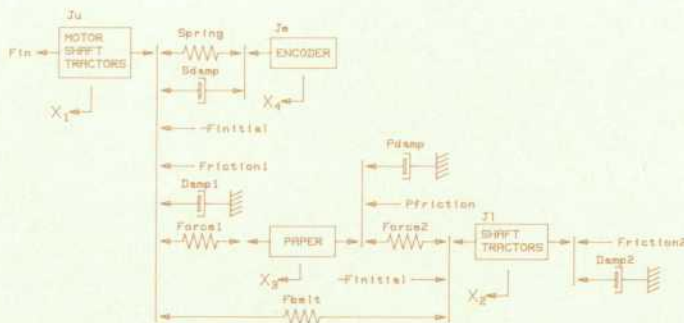

Fig. 1. Torque versus position for the step motor used in the HP 2565/6A paper drive mechanism.



$$\begin{aligned} \dot{X}_1 &= R^2/J_u(F_{in} - \text{Force1} - \text{Friction1} + \text{SGN}(X_1) - \text{Damp1} \cdot X_1 - F_{belt} + F_{initial} - \text{Spring} \cdot (X_1 - X_4) - \text{Sdamp} \cdot (X_1 - X_4)) \\ \dot{X}_2 &= R^2/J_l(\text{Force2} + F_{belt} - F_{initial} - \text{Friction2} + \text{SGN}(X_2) - \text{Damp2} \cdot X_2) \\ \dot{X}_3 &= 1/M_{paper}(\text{Force1} - \text{Force2} - P_{friction} - P_{damp} \cdot X_3) \\ \dot{X}_4 &= R^2/J_e(\text{Spring} \cdot (X_1 - X_4) + \text{Sdamp} \cdot (X_1 - X_4)) \end{aligned}$$

Fig. 2. Model of the paper drive mechanism.

used the Runge-Kutta method to solve the equations that describe the paper drive system (Fig. 2). On an early breadboard printer, the model and the actual data compared very closely. The dot placement accuracy of the breadboard resulted in print that was readable but not as good as desired. That performance served as the limit for the print quality specification. Input variables used by the model were changed to see what effect they would have on the paper motion. A subsequent design change achieved greater dot placement accuracy. The data from the new design matched the predicted behavior from the model fairly closely. The final analysis showed the paper motion to be accurate to ± 0.0015 inch as shown by both the data and the model (see Figs. 3 and 4).

Peter Gysling
Development Engineer
Boise Division

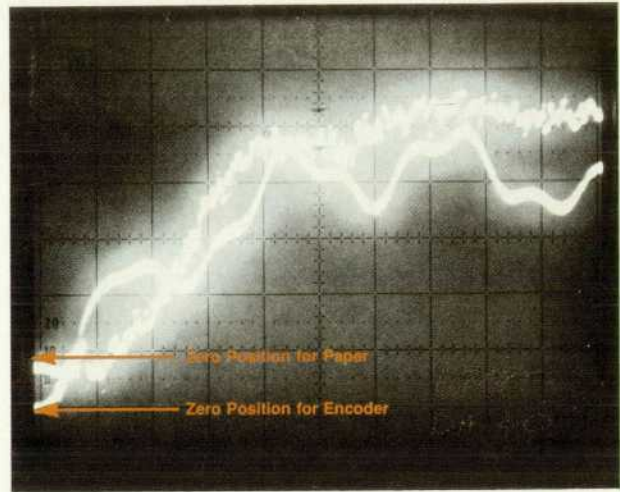
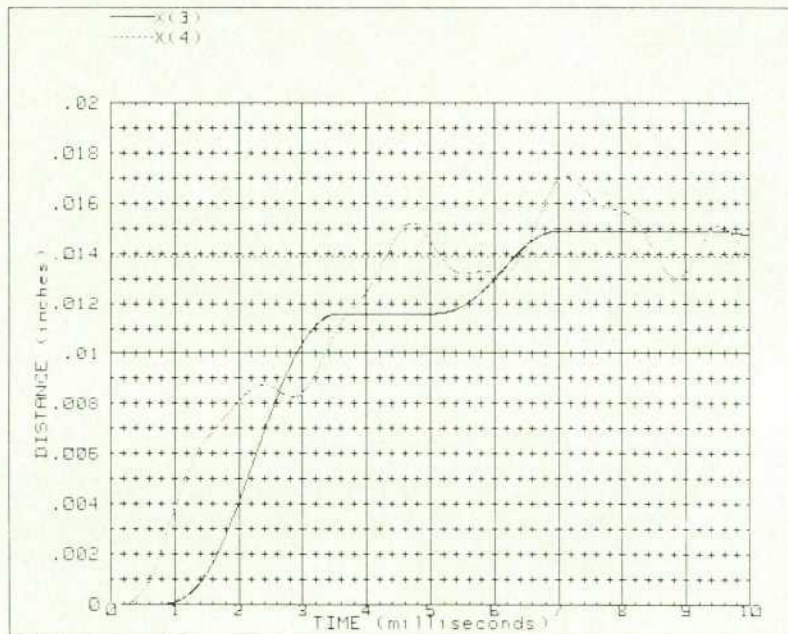

Fig. 4. Actual paper and encoder positions agree well with model data.

DIRECT DRIVE TO UPPER SHAFT, TENSIONED BELT TO LOWER SHAFT, ENCODER, WITH PAPER
LOW DENSITY HALF STEPPING WITH A 2-DEGREE STEPPER MOTOR.
SEGMENT NUMBER 1



VARIABLES PLOTTED:

X(3): PAPER POSITION
X(4): ENCODER POSITION

DELAY TO HOLD IS 3.4 MILLISECONDS. 0
 MAXIMUM VALUE OF STEP TORQUE CURVE IS 170 OZ-IN. 0
 MAXIMUM VALUE OF HOLDING TORQUE CURVE IS 90 OZ-IN. 0
 PLAY BETWEEN SHAFT AND TRACTOR PULLEYS IS 0 0
 THERE ARE 1000 INTEGRATION POINTS IN THE WINDOW 0
 JU= .00428 , JL= .003 , JE= .000584 , JI= 0 , JM= 0 0
 FRICTION1= 20 , FRICTION2= 10 , Mfriction= 0 0
 PAPER FRICTION= 4.5 OZ STATIC, 4.2 OZ KINETIC. 0
 DAMP1= .341 , DAMP2= .037 , Mdamp= 0 , Sdamp= .6 0
 Kbelt= 37000 , Bbelt= 0 , Mbelt= 0 0
 Mpaper= .00053 , Pdamp= .8 , Kpaper= 2200 , Ptenstion= 0 0
 Ktenstion= 2 , BELT TENSION= 110 , Spring= 88000 0
 INITIAL TENSION = 15 , TRACTOR FEED RATE= 2.5 IN/REV, PULLEY DIAMETER= 1.56
 YNT(1) = 1.43286086795E-02 YNT(2) = 1.22783356076E-02
 YNT(3) = .014705906935 YNT(4) = 1.37859801363E-02
 YNT(5) = -.403280379806 YNT(6) = -1.34423073846
 YNT(7) = -.714809644316 YNT(8) = -2.64178535078

Fig. 3. Computer-calculated model behavior.

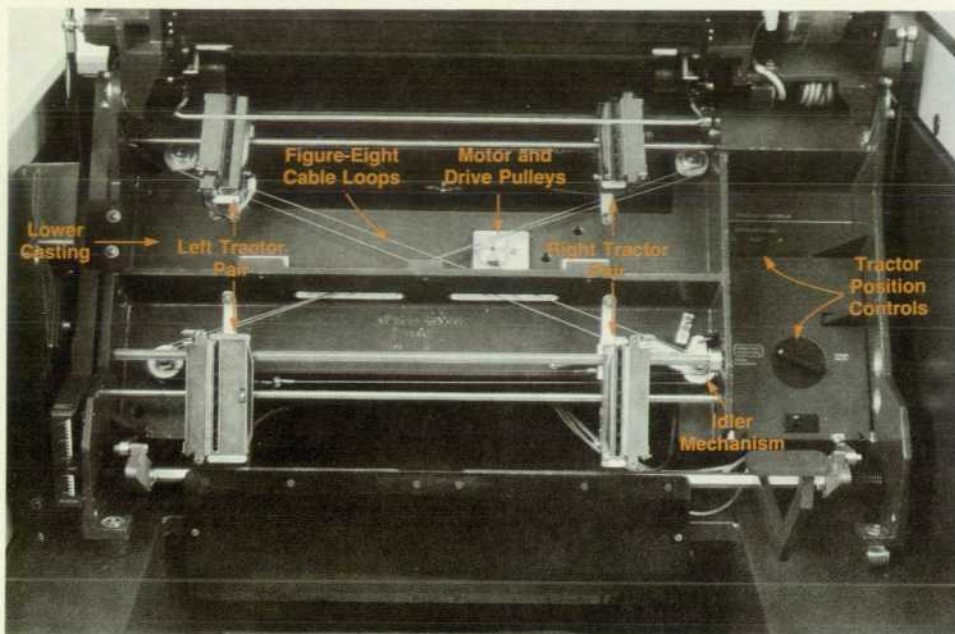

Fig. 4. Power tractor positioning of the HP 2565/6A Line Printers.

(continued from page 14)

Fig. 3, page 14, shows how the propagation of web wrinkle is corrected. The ribbon passes over bowed guide rods, which substantially dewrinkle the web. The guide rods are positioned on both sides of the hammer bank, adjacent to the ribbon spools. Because the ribbon reverses direction at the end of its travel, the guide rods serve to

smooth the web both when it is supplied and when it is taken up by the spools. Another advantage of the system is that the ribbon is dewrinkled before it passes by the hammers, which improves print quality and prevents folding of the wrinkles when the hammers strike the web.

The guide rods are bowed by means of two small shims, which offset two thin-walled cylinders mounted around a stiff inner rod. A shoulder insert supports the tubes in the middle of the rod, creating a central crown. The slope of the crown was determined empirically to minimize wrinkles in ribbons of varying age. The tubes are electrically isolated from each other and also serve as end-of-ribbon sensors. When the end of the ribbon is near, a flexible aluminum foil patch glued to the ribbon contacts both tubes simultaneously and causes the ribbon drive motors to reverse direction.

Resonance Search Technique

The control processor tests and tunes the servo system that drives the printbar during power-up or reset to determine the resonant frequency of the print mechanism. A self-test is first executed to check out the print servo system. A failed test reports an error to the operator panel and host computer and prevents the servo from entering a print ready state. A passed test allows the print mechanism resonance search process to begin. The printbar reciprocating frequencies for the two HP 2565/6A Printers are different. The nominal frequencies are: 40 Hz (HP 2565A) and 60 Hz (HP 2566A). Because of unit-to-unit variations, printers deviate slightly from these established nominal values; yet each print mechanism must be driven at its actual resonant frequency. Hence, the control processor must be able to determine the minimum-power operating frequency for the particular printer. The process of doing this is called tuning.

Tuning begins by forcing the servo system off and then applying a short-duration disturbance to emulate an impulse. After a short delay to permit higher-frequency transients to die out, the period of the damped sinusoid response is measured. The measured frequency constitutes a rough guess that is used as a starting point for a subsequent fine-tune gradient search over neighboring frequencies until the minimum-power operating frequency has been found. This frequency is used until the next power-up or reset cycle.

Gary W. Green
Development Engineer
Boise Division

Open-Throat Paper Path

The printer-operator interface is improved by means of the open-throat paper path geometry used in the HP 2565/6A Printers. The print mechanism consists of two major assemblies: the lower casting and the swing gate. The lower casting contains the tractors, power tractor positioning system, and paper guides. The swing gate includes the printbar, linear motor, and ribbon drive system.

The swing gate can be swung up out of the way when the operator requires unobstructed access to the paper path for loading. Because there are four tractors, the waste of prenumbered forms can be minimized. When the last form in one box has been printed, the form is stopped between the upper and lower tractors. Here the top form of the next box can be spliced to the previous form for continued printing. With the swing gate in the up position, the operator can also adjust the tractors to the correct width for the form being printed.

The paper path is slightly curved to provide a smooth, gradual transition from the lower tractors to the upper tractors. This characteristic helps minimize the number of

paper jams.

The optimum paper viewing angle for an operator standing at the front of the printer is approximately 30 degrees from horizontal. This angle for the upper tractors works very well in creating a jam-free exit path for the paper, primarily because the paper is being directed at a low enough angle to keep it from lifting off the paper guides at high paper slew speeds.

The angle of the lower tractors was chosen with two constraints. One was to pull the paper out of the box as directly as possible to minimize paper feed problems. The second was to keep the angle between the upper and lower tractors as small as possible to decrease the chances of paper jams in the throat area.

Power Tractor Positioning

Because the HP 2565/6A Printers have four tractors, a system had to be designed to adjust the tractors for different form widths and to position the paper properly in the printer while maintaining precise vertical alignment of the tractors. This is accomplished by the use of cables, an idler mechanism, and a drive motor (Fig. 4).

The left and right tractor pairs are connected to separate figure-eight cable loops. The cables allow independent horizontal motion of the left and right pairs while forcing the upper and lower tractors in a pair to move together. A spring is inserted in each figure-eight loop to provide ten-

sion and compensate for any stretching of the cable. Two drive pulleys are coupled to a reversible motor by a common shaft. Each cable is wrapped around its respective drive pulley so that rotation of the drive motor shaft causes the tractor pairs to move. A spring-loaded cable idler mechanism can release the tension on one cable while also applying a brake so that the left tractors remain stationary while the right tractors move to adjust for form width. Once the correct form width has been set, the cable idler and brake are released so that all four tractors move together.

The tractor pairs can be moved in either direction and at two different speeds. A fast speed is provided to make coarse paper position adjustments, while a slow speed is provided for fine adjustments in paper position or horizontal paper tension.

Acknowledgments

Lynn Hessing provided the latching concepts and designs for the print mechanism and designed the linear motor and flexures. Warren Wardlow designed the frame and panels and provided the mounting scheme for the printer electronics. Bill Misson was responsible for the mechanics of the ribbon drive control system and designed the bowed guide rods described in the article. Jim Girard provided industrial design assistance and was responsible for the preliminary form and layout of the panels.

Cost-Effective, Versatile Line Printer Electronics and Firmware

by Philip Gordon, Phillip R. Luque, and Donald K. Wadley

ELECTRICAL DESIGN of the HP 256X family of line printers emphasized close coupling between the electronics and the firmware to meet the cost, flexibility, and performance objectives. The digital control electronics consists of the I/O, control processor, and dot generation logic (DGL) sections. Data passes through the I/O system, is formatted by the control processor, and is finally converted to properly sequenced dots for the print mechanism by the DGL (Fig. 1).

Each I/O interface is a separate printed circuit assembly that consists of not only the specific interface electronics but also a Z80A microprocessor, firmware ROM, and RAM. This system converts protocol specific information into a universal format expected by the main control processor. Interfaces may be exchanged easily without modifying or reconfiguring main control processor firmware. Interfaces available on all HP 256X Printers include RS-232-C, RS-422-A, and multipoint serial interfaces, and HP-IB (IEEE 488), differential, Centronics, and Dataproducts parallel

interfaces.

The main control processor system includes the microprocessor, firmware ROM, and RAM, along with interrupt control, timing, and bus interfacing support electronics. The microprocessor components used are the Z80A (HP 2563A) and the 8088 (HP 2565A and HP 2566A). All printers share the identical operator panel assembly and manner of use.

Processor Firmware

Control processor firmware is divided into logical and physical printer firmware. Logical firmware, written primarily in a high-level language, is the personality of the printer that is visible to the user and host computer. It receives the data and control information from the I/O system, performs the requisite escape sequence parsing, formats this into logical print data lines, and places the result in a queue for future printing. The logical firmware, however, has no knowledge or control over how this formatted

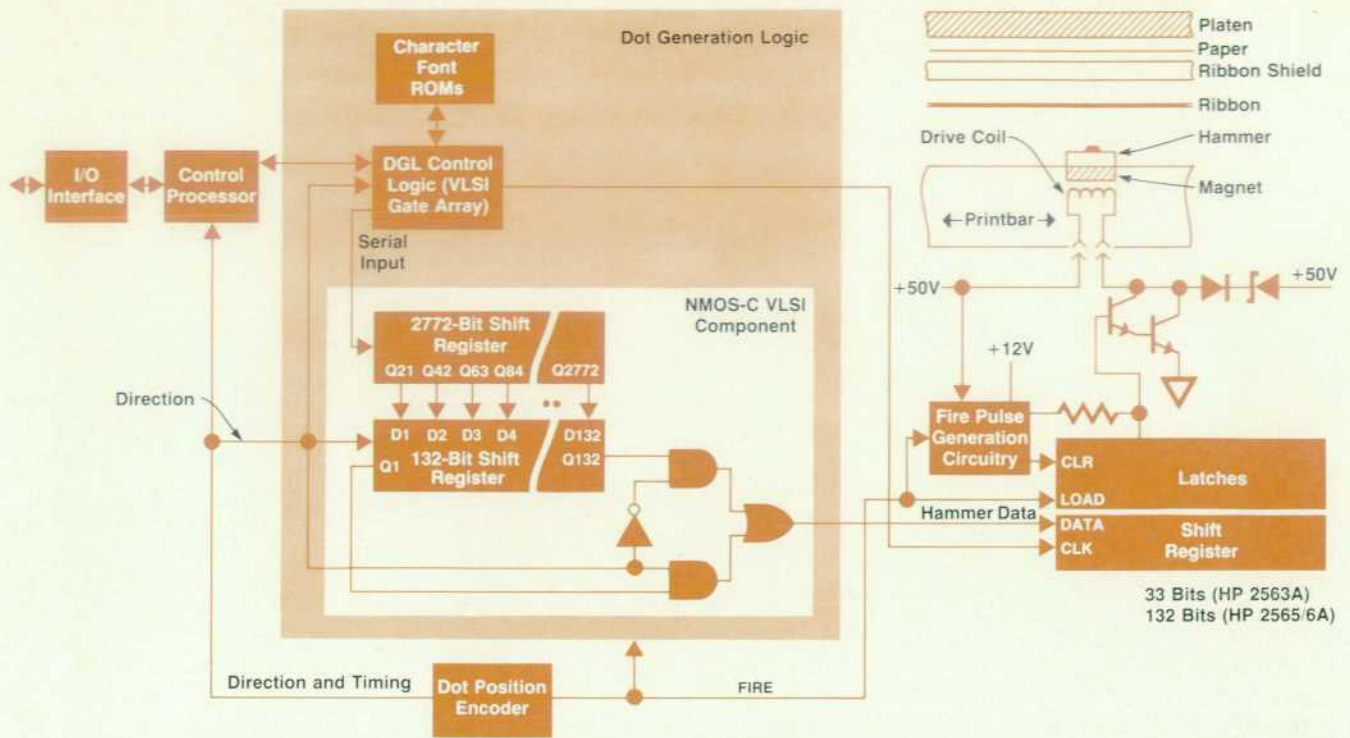

Fig. 1. Dot generation logic and hammer driving circuit block diagram.

information is ultimately printed by the mechanism. It is the physical firmware that accepts the queued print data and performs the detailed operations to complete the printing task. These functions include synchronizing all electronic and mechanical systems of the print process, setting up the DGL to convert this information into properly sequenced dots, programming the dot position encoding system to ensure correct hammer firing, establishing printbar motion requirements, stepping the paper, and so on. The physical firmware, written primarily in low-level micro-processor instructions, is optimized for the electronics and

mechanisms in the specific printer. Although the physical firmware is nearly identical for the similar HP 2565/6A Printers, it is very unlike that of the fundamentally different HP 2563A Printer.

Self-test firmware is also divided within the logical and physical firmware spaces. Self-test structuring, digital hardware tests, print pattern tests, and other leveragable mechanism-independent functions are about 80% of the self-test and are located within the logical firmware. The remaining mechanism-dependent functions, such as the printbar tuning process (see box, page 17), are placed

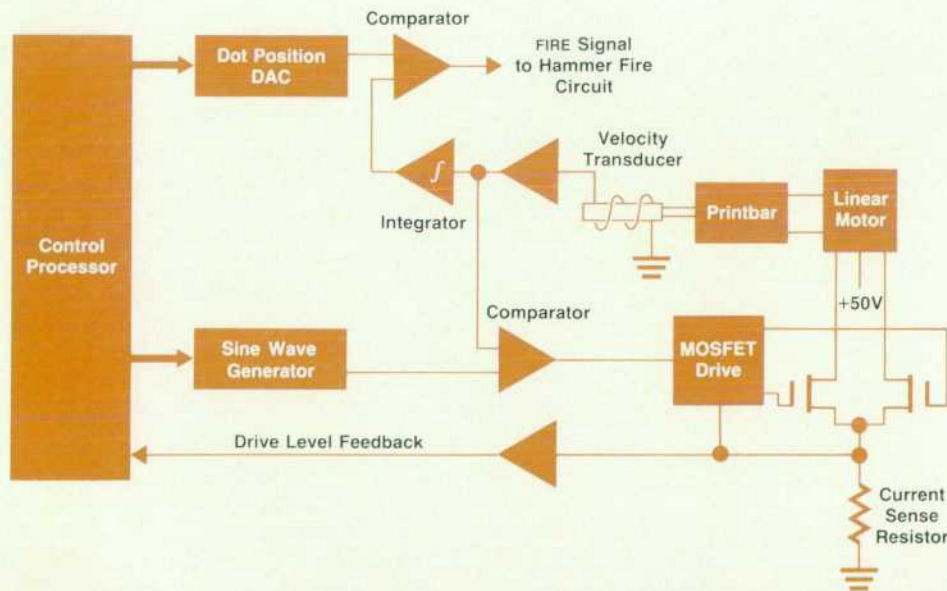

Fig. 2. HP 2565/6A servo system controls printbar motion and hammer firing.

Vector Graphics for Dot Matrix Printers

An optional printed circuit assembly, the HP 26061A, gives plotter-like vector graphics capability to the HP 256X family of dot matrix line printers. This option not only frees the host computer from computation-intensive vector-to-raster conversion, but it also does these conversions much more quickly because it is specifically designed for this purpose.

The heart of the HP 26061A is the μ PD 7220 graphics display controller (GDC) chip, which can convert single-dot-wide vectors into their corresponding pixels at a rate of up to 750,000 pixels per second. The GDC sets the pixels in a dynamic RAM bit map. Once a graph is completed, the dot image is sent to the HP 256X DGL (dot generation logic) to be printed at either 70 dpi resolution for high speed or 140 dpi resolution for high quality. There are two versions of this option; one has a 128K-byte bit map and the other has a 512K-byte bit map. The 128K-byte version can create a maximum 13.2-by-15.6-inch graph at 70 dpi, or a 7.3-by-7.1-inch graph at 140 dpi. The 512K-byte version can create a 13.2-by-62.7-inch graph at 70 dpi, or a 13.2-by-15.6-inch graph at 140 dpi. Other sizes can be programmed as long as the graphs have the same number of pixels. Because the GDC is only used to draw single-dot-wide lines, an 8088 microprocessor breaks down all the high-level graphics commands into single-dot-wide lines. The microprocessor requires 48K bytes of assembly language code because of the high level of graphics functionality supported. Running in parallel, the GDC and the 8088 can convert up to 700 vectors per second. The HP 26061A receives vector graphics commands from the host in a format that is modeled after the emerging ANSI computer graphics metafile standard (dp ANS X3.122, *Information Processing Systems Computer Graphics Metafile for the Storage and Transfer of Picture Description Information*). It supports a high-level set of graphics primitives including lines, circles, arcs, polygons, area fills, markers, and text. A large number of attributes may be set to alter the appearance of these graphics primitives. These attributes include line width, line style, perimeter width,

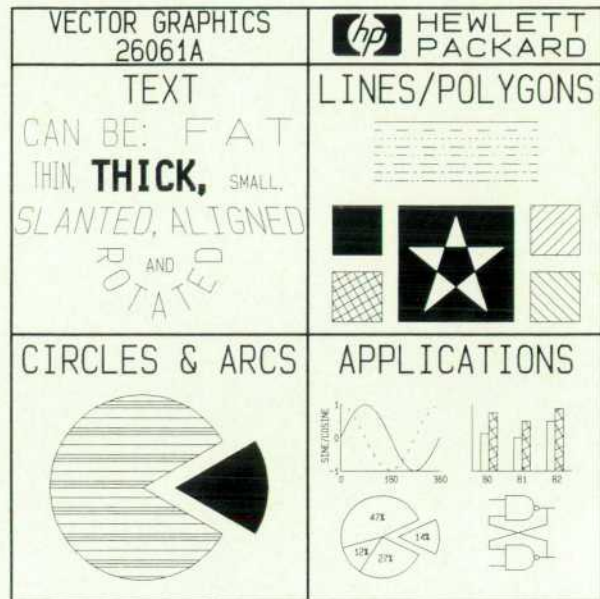

Fig. 1. A sample of graphics output from a member of the HP 256X family of line printers with the HP 26061A option installed ($1/3$ actual size).

perimeter style, fill style, and text size, orientation, slant, direction, and alignment (see Fig. 1). In addition, the HP 26061A supports mapping and scaling transformations and clipping.

Sharon E. Jones
Alvin D. Scholten
Development Engineers
Boise Division

within the physical firmware space.

Logical firmware leverage and ease of system integration are the two principal benefits of dividing the control processor firmware in this way. Since the logical firmware is essentially independent of the print mechanism and the choice of I/O interface, it was quickly and easily transported to the different printers of the HP 256X family. This ensures feature compatibility between different members of the family.

System integration and conformance testing are the extremely important, yet time-consuming tasks that verify proper printer operation with a myriad of supported computer families and system configurations. Once the logical firmware has been verified to meet all published specifications for one printer, subsequent printers employing the same logical firmware can be tested more rapidly but no less exhaustively.

Dot Generation Logic

The main control processor does not have the bandwidth to convert the ASCII or otherwise coded data into a corresponding dot image or to sequence these dot images prop-

erly for the hammer driving electronics. The state-machine-controlled DGL system performs these tasks. The universal DGL system needs to be very low-cost for the HP 2563A Printer and high-speed for the HP 2566A Printer. Because DGL systems have historically required a painful number of standard TTL components, ours is implemented using VLSI technology.

Since all available character fonts are stored in ROM adjacent to the DGL, generation of the proper font dot images is a simple and rapid lookup process. Sequencing and ordering these dot images for the hammer driving electronics is a much more troublesome task. Although dot matrix impact line printers appear to print a single dot row at a time, the hammer driving circuits cannot collectively accept simple raster-scan dot data as a video display unit does. As the printbar on the 132-hammer HP 2565/6A Line Printers moves from one extreme position to the other, each hammer passes across its exclusive 0.1-inch-wide print area. Since this printbar covers 13.2 inches of paper at a maximum dot resolution of 210 dots/inch (dpi) for a total of 2772 dot positions, the first 132 dots printed simultaneously are scattered 21 dots apart within the row. The

next 132 dots printed simultaneously are still 21 dots apart but adjacent to the previous ones. Therefore, the printbar, viewed as a unit, appears as a group of 132 disjointed raster scans. Dot image data must be ordered to compensate for this printbar geometry. For today's versatile line printers that provide variable dot resolutions and multiple character pitches, and allow character or bar code element pitches to change within a print row, the amount of arithmetic and control logic needed to perform dot sequencing is substantial.

The solution for the HP 256X family of line printers is a smart shift register that acts as both a full line buffer and an automatic dot sequencer. This shift register is 2772 bits long, one storage cell for every dot that can be placed across a print row. It also has 132 output taps spaced every 21 bits along its length—one tap for each hammer in the printer. The number of storage cells between the taps equals the maximum number of dots each hammer can reach and print in a pass of the printbar. This shift register accepts simple raster-scan data because it precisely complements the geometry of the printbar. The DGL easily fills this shift register with the entire dot image for the row during the nonprinting printbar turnaround time. Then this shift register is clocked once each time the hammers are activated to bring the next set of printable dots to the taps.

The VLSI Solution

Large standard static shift registers are unsuitable for such an application since they are accessed serially and no taps are provided. A custom VLSI component is required to make this design an economic reality. But since a 132-hammer line printer requires as many output taps, a VLSI component would immediately encounter a costly packaging problem. To limit package pins, an integral 132-bit parallel-to-serial output shift register (Fig. 1) is loaded from the taps of the main shift register and is then repeatedly clocked to shift this data serially into the hammer driver shift register. This output shift register is bidirectional to help accommodate the two print motion directions. When this VLSI component is used in the 33-hammer HP 2563A Printer, a divide-by-four circuit stores every fourth bit from the output shift register into the 33-bit hammer driver shift register. Proper synchronization guarantees that the other 99 output bits are discarded. The VLSI component appears as the same 2772-bit main shift register with only 33 useful

taps now 84 bits apart, with a 33-bit output shift register.

The HP NMOS-C process was selected for its low cost and adaptability to full custom circuit design. Circuit design and mask layout were done by HP's Boise Division, while part fabrication is done by the Cupertino IC Division. A 2772-bit single-direction main shift register is combined with a bidirectional 132-bit output shift register to limit package pins to 16. Design expenses and risks were minimized because the chip layout is a repetitive series of several varieties of shift register cells. Depletion-mode FETs, used as pull-up resistors, were made as large as possible to reduce power dissipation and permit the use of a plastic DIP, but were constrained to be small enough to guarantee the minimum operating frequency and economical die size. Approximately 24,000 FETs are fabricated on a die 3.68 mm by 5.46 mm. The cost of this part is comparable to a RAM, which would otherwise be required for storing the row dot image, yet it does much more.

Variable dot resolution capability was added to the DGL to accommodate applications requiring a resolution less than the maximum 210 dpi. The distance between the active taps in the main shift register must be effectively reduced. This is accomplished with additional control logic that periodically interrupts the simple filling procedure of the main shift register to inject a specific number of dummy fill bits. For example, in a 132-hammer printer programmed for 140 dpi, 7 dummy fill bits would follow every 14 printable dots passed into the main shift register. This padding process ensures that the actual printable bits, isolated in groups by the dummy fill bits, are directly beneath the taps of the main shift register. The dot position encoding system divides the print space into fewer but larger intervals so that only these actual printable dots are drawn out through the taps and passed to the hammer fire electronics. The fill bits are abandoned since they just reach the taps at the very completion of the printbar pass. In the HP 256X family of line printers, standard 10-pitch characters are printed at the default 210 dpi resolution, compressed 16.67-pitch characters are printed at 200 dpi resolution, and graphics printing is done at both 70 dpi and 140 dpi. The readability of optically scanned bar codes is established by the width ratio of the narrow and wide bars and spaces, which in turn is determined by dot size and dot resolution. For the nominal dot size of these printers, special bar code resolutions of 100 dpi and 110 dpi are used to meet military standards.

Although the DGL control electronics required to fill the smart shift register is relatively elementary, this logic was placed in a small CMOS gate array to achieve additional cost savings and reliability.

Hammer Driver Circuits

All HP 256X Printers have very similar circuits to drive the print hammers. The hammer driver shift register receives serial dot data from the 2772-bit shift register via the 132-bit output shift register of the DGL. Once this data is loaded, it is clocked into a set of data latches by the FIRE signal from the dot position encoder circuitry (Fig. 1). Each of these latches drives the base of a Darlington transistor, which is connected to a hammer coil. When a transistor is energized, current flows through the hammer coil and

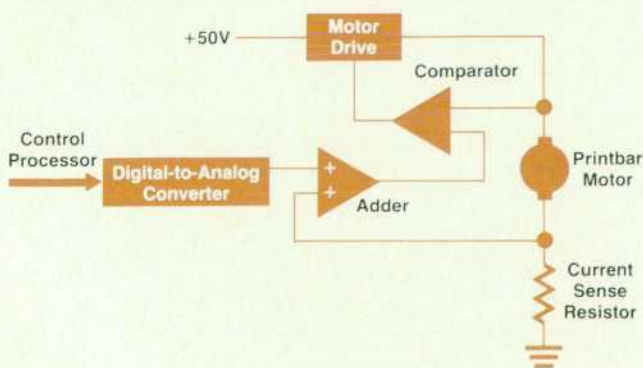

Fig. 3. HP 2563A servo system maintains constant motor speed.

creates a magnetic field that counteracts the field of the hammer's permanent magnet, releasing the hammer to print a dot. The fire pulse generation circuitry also provides a signal to clear the shift register latch and turn all the drive transistors off. This is because the fire pulse circuit monitors the very loosely regulated +50V supply and varies the hammer fire signal duration based on the voltage level. (If the +50V supply is relatively high, the hammers fire for a shorter time and vice versa). Power Zener diodes are used to drain off the energy stored in the hammer coils when the Darlington transistors are turned off.

Printbar Servo Systems

The servo system in the HP 2565/6A Printers controls the sinusoidal motion of the printbar and supplies position pulses to the hammer drive circuit (Fig. 2). The velocity input for the servo loop is supplied by a sine wave generator whose frequency and amplitude are determined by the control processor. The processor programs a counter, which addresses a ROM containing a digitized sine wave. The ROM output goes to a DAC (digital-to-analog converter) to produce an analog sine wave. The amplitude of the sine wave is established by adjusting the reference input of the DAC by means of a second DAC, which is also controlled by the control processor. The sine wave is compared to the signal from a magnetic velocity transducer attached to the printbar. The resulting error voltage sets the current level for the pair of power MOSFETs that drive the linear motor attached to the printbar. The frequency and amplitude of the printbar motion can thus be controlled by the control processor. A digital signal representing the peak drive level is also fed back to the processor so that it can sense the resonant frequency of the printbar flexure system (see box, page 17). A voltage proportional to the printbar position is produced by integrating the velocity signal. As the printbar moves, this voltage is compared to a second volt-

age, generated by a third DAC controlled by the control processor, representing the next dot position. When these voltages are equal, a FIRE signal is sent to the hammer drive circuit and the DGL is flagged to output the hammer print data for the next dot position.

In the HP 2563A, sinusoidal printbar motion comes by virtue of the crankshaft, which is driven by a dc servo motor. A servo system maintains a constant motor speed of 17.5 revolutions per second, or 28.57 ms per single pass of the printbar (Fig. 3). Since uppercase characters are seven dot rows high, this establishes a 300 line-per-minute print speed. The drive circuit for the printbar motor is basically a variable-voltage power supply. The voltage is determined by the control processor through a DAC. Since it can measure the printbar reciprocation rate by timing direction change interrupts from the position encoder, the processor controls the average speed of the motor. However, a hardware feedback loop is also used to increase the bandwidth of the motor speed control and control the motor speed within a single cycle. The motor current is measured using a sense resistor, and a voltage proportional to the motor current is added to the reference voltage from the DAC. This compensates for the voltage drop in the motor resistance.

A linear capacitive encoder is used in the HP 2563A to measure the position of the printbar with respect to the print mechanism casting (Fig. 4). The encoder includes two printed circuit assemblies. One is attached to the casting and holds the analog and digital electronics. The other, called the pickup plate, has no active circuitry and is attached to the printbar. A transmitter pattern, consisting of five sets of eight fingers, is etched on the back of the active encoder printed circuit assembly. The fingers are spaced on 0.032-inch centers so that each set of eight fingers spans 0.256 inch. Each finger of a set is connected to the corresponding finger of the other sets. The signals to the transmitter pattern are generated by an 11-MHz clock, which is divided by an eight-bit counter. The fifth and eighth bits of the counter are used to gate and clock an eight-bit shift register. The shift register generates an eight-phase pattern of square waves, which are connected to the fingers of the transmitter pattern. The printbar pickup plate has four etched fingers and is positioned directly over the transmitter pattern on the encoder board. Since each pickup plate finger is 0.128 inch wide and hence spans four fingers of the transmitter pattern, each pickup finger capacitively sums the output of the four transmitter fingers below it. The signals from the pickup fingers are capacitively coupled back to the encoder board and are amplified and filtered to produce a sine wave whose phase is linearly proportional to the position of the printbar with respect to the mechanism casting. One cycle of phase shift (360 degrees) represents 0.256 inch of printbar movement. After the signal from the pickup plate has been amplified, it is used to latch the state of the first two bits of the counter into a pair of flip-flops. The latched value, representing the least-significant bits of the phase of the output signal at that instant of time, is simply the position of the printbar in 0.001-inch increments. The flip-flop outputs are inputs to a state machine, which generates a direction signal, a change-of-direction strobe, and a strobe that is active every

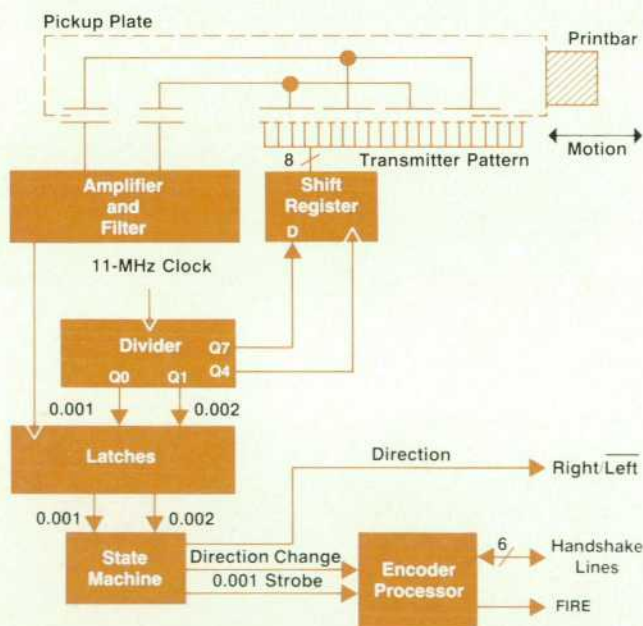

Fig. 4. A linear capacitive encoder is used to measure the position of the HP 2563A printbar.

time the printbar moves 0.001 inch in any direction. The state machine also adds 0.001 inch of hysteresis so that the direction signal does not toggle on phase noise, which is inevitably present on the pickup plate signal. The outputs from the state machine go to the encoder processor (an 8049) which has 4096 bytes of internal ROM to store both program steps and dot resolution tables. The dot resolution tables map the 0.001-inch strobe from the state machine into the FIRE pulses required to strobe the hammer drive circuit for the various HP 2563A print resolutions. The encoder processor also monitors the printbar motion and adds an offset to the dot tables to compensate for printbar travel between the time of hammer activation and the flight time to the ribbon and paper. This ensures that the dot print positions as the printbar moves from right to left fall directly over the print positions as the printbar moves from left to right.

Ribbon and Paper Step Drive

The HP 2565/6A ribbon drive moves the 14.5-inch-wide towel ribbon from a supply reel to a take-up reel and back with controlled velocity and tension. Two series-connected motors, each driving one reel, are used. A constant voltage is applied across the two motors with a current sink taking a constant current from the common node. This current controls the ribbon tension. Both motors drive in the same direction when moving the ribbon, with the majority of the torque supplied by the pulling motor.

The HP 2563A ribbon cartridge uses a continuous 3/4-inch-wide ribbon pulled horizontally across the printbar. A geared shaded-pole induction motor, controlled by an

SCR, is wound to operate from 30Vac so that it can be run from the secondary of the power transformer.

Permanent-magnet step motors are used by all 256X Printers for paper motion. The control processor controls the phase selection and timing. Each full step from the motor advances the paper 1/2 inch, which is the dot spacing for standard print densities. For high-density printing, the motor is half-stepped, advancing the paper 1/44 inch.

Acknowledgments

Bill Weiser designed the printbar servo control system and the paper step electronics and Steve Folkner the hammer driving electronics for the HP 2563A Printer. Janet Sanders, Tom Wheless, Clyde Gregg, and Ken Wade helped develop the HP 2563A digital control electronics and firmware, the HP 2563A encoder firmware, and the HP 256X family operator panel. Bob Deely managed the HP 2563A electronics and firmware development during its final design phase. Bob Gunter designed the servo control electronics, Fred Weideback the motor control electronics, and Bill Pierce the power supply for the HP 2565/6A Printers. Terry Loseke managed the electronics development. The HP 2565/6A digital control electronics and firmware were developed by Joe Buehler, Dellas Frederiksen, Richard Wheeling, and Gary Green. Seana Lahey and Russ Campbell performed the system verification testing. Wes Nielsen, Jerry Loyd, and Gary Carlson designed the universal I/O assemblies. Alvin Scholten and Sharon Jones designed the HP 26061A vector graphics hardware and firmware. Gary Gapp managed the development of the I/O interfaces and the vector graphics option.

Printer Command Language Provides Feature Set Standard for HP Printers

by Ernest F. Covelli, Von L. Hansen, and David L. Price

PRINTER COMMAND LANGUAGE (PCL) is a standard language developed by HP to define printer features and user access to those features. In the past, printers developed by HP and other manufacturers were designed with features that were different from device to device. Each new printer contained features that were tailored to the printer's particular mechanism or to a specific application. Application programs written for one printer often had to be rewritten or modified to work correctly with another printer. Each new printer required several months or even years of software development to support its new features. This proliferation of printers and applications created a problem known as the "M by N" problem, where M is the number of software applications and N is the number of printers. Every time a new printer was intro-

duced, all M applications required modification to support the printer. Likewise, each new software application had to support N different printers.

PCL was developed to bring all HP printers under a common feature and control structure. The major objectives of PCL are to standardize printer features and to standardize how features are accessed and implemented. PCL is the protocol that addresses the control of printer features by user or system application programs. This is the highest level of communication between the system and printer. PCL does not address the lower levels of the system structure, such as driver control, network communications, or I/O interfaces.

PCL Architecture

It was determined that no single set of printer features could meet the needs of all printer markets. For example, to define the standard feature set as a combination of all desired features would make the low-cost printer too expensive. Likewise, to prohibit advanced features in the PCL standard would restrict high-level applications and printer markets needing advanced features. The solution was to partition the printer market into four major application segments: print and space, electronic data processing (EDP) and transaction, word processing, and page formatting. PCL was then aligned with the four major market segments:

- Level I Print and Space
- Level II EDP and Transaction
- Level III Word Processing
- Level IV Page Formatting.

Each level provides a well-defined set of features that address the needs of its respective market. Each PCL level is a proper superset of the next lower level, assuring upward compatibility. This structure allows applications to be leveraged to printers at or above the level for which the application was written. Any application written using the Level I (print and space) features will format correctly on any HP printer. A Level IV (page formatter) printer can run any PCL application.

The features in the PCL levels are designed to meet the needs of the four major markets and to be device independent for use with many print engine technologies. Also, the PCL structure allows for optional features outside the level structure. Optional features provide the flexibility to offer a printer-dependent feature or to meet a special market application. Examples of optional features include bar codes, vector graphics, downloadable fonts, and sheet-feeder control. Applications using optional features will not work correctly on printers that do not support the optional features.

All printers using the PCL architecture must implement features identically and in full compliance with a specific PCL level or be clear about any exceptions, and must be specific about optional features that are outside the level structure.

Feature Level Overview

The print and space feature set level (Level I) is designed to meet the needs of a low-cost single-user workstation with entry-level functionality. The basic feature required for a print and space printer is the ability to print ASCII data at 80 characters per line using the normal pitch font and 132 characters per line using the compressed pitch font. In addition, all PCL printers implement the HP eight-bit character set standard, which supports eleven European languages. Printer features are accessed by ASCII control codes and escape sequences. The control codes supported at this level are: line feed, form feed, carriage return, space, and shift in and shift out between the primary and secondary fonts. Additional printing features such as automatic underline, automatic perforation skip, and raster graphics are controlled by escape sequence commands.

The Level II feature set is intended for general-purpose applications such as EDP and transaction printing. Printers at this level can be single-user or multiuser devices with

Table I

Hewlett-Packard PCL-Compatible Printers

Print and Space	EDP and Transaction	Word Processing	Page Formatting
2671G 2673A 2674A 82905A ThinkJet	256X 82906A 2932A	LaserJet 2934A	Future Products

a wide range of performance requirements. EDP printers use a variety of forms and paper sizes, so features added in this level give the application control of the paper size, text length, and margins. Additional control of character placement is provided by a cursor move to any character row or column position.

The Level III feature set is tailored to word processing applications, where high-quality text formatting capabilities are required. Today there are many devices that fit into the word processing level. These include the traditional daisy wheel and multipass scanning head printers, and the latest laser and ink-jet printers. Word processing requires a variety of print pitches—ten or twelve characters per inch, compressed, and proportional—in upright, italic, and bold type styles. All available fonts may be mixed in any fashion on a page or line. Word processing requires the ability to do superscripts, subscripts, and precise character positioning for centering and justification of text.

The page formatting Level IV feature set is tailored to office information applications requiring advanced text and graphics formatting capabilities. Page formatting features include downloadable fonts, high-quality raster graphics, electronic forms, page rotation, a variety of font sizes, rectangular area fill patterns, and rules. Electronic forms provide a replacement for preprinted forms, which require special operator handling and storage. Page rotation provides the ability to print either vertically or horizontally. This additional flexibility is needed to address the many types of office applications, such as spreadsheets, reports, listings, and documents. Font handling has been expanded to include small footnote and large display fonts for better document presentation and low-end printing and publishing applications. Downloadable fonts give the application control over the fonts in a printer, allowing the use of custom and HP-supplied fonts.

Conclusion

The PCL is a standard that provides consistency among HP printers. The features in the levels address the needs of the major market segments, while allowing optional features for special applications. PCL has been successfully implemented on many HP printers ranging from a workstation printer like the ThinkJet Printer to system printers like the HP256X family of line printers (see Table I). These PCL printers use a wide variety of printing technologies such as thermal ink-jet, electrophotography, serial dot matrix, and line printer dot matrix. New markets have been opened because of PCL's consistent structure and product offerings.

PCL will help us continue to meet the present and future printing needs of our customers.

Acknowledgments

The PCL standard was developed jointly by HP's Boise and Vancouver Divisions. We wish to extend our thanks to all of the members of the PCL committee, especially John Ignoffo, Jim Langley, Carol Peterman, Mike Ard, and Mike Sproviero, for making PCL a successful interdivisional effort.

Authors

June 1985

4 — Dot Matrix Line Printers

Bryce E. Jeppsen



Now R&D manager at HP's Boise Division, Bryce Jeppsen was born in Brigham City, Utah and earned both a BS degree and an MSEE degree from Brigham Young University in 1970. He also served in the U.S. Army for two years.

At HP since 1970, he has contributed to the development of a number of products, including the HP 5430A Microwave Frequency Counter, the HP 5345A Electronic Counter, and the HP 10590A Plug-In Adapter. He also served as project and section manager during the development of the HP 256X family of printers. Bryce is a resident of Meridian, Idaho and works with church youth groups. He is interested in radio-controlled airplanes and boats.

6 — Printbar Design

John S. Craven



Born in San Francisco, California, John Craven attended the University of California at Berkeley, earning a BSME degree in 1971 and an MSME degree in 1975. He joined HP's Avondale Division in 1975 and contributed to the design of the thermal conduc-

tivity detector for the HP 5880A Gas Chromatograph and to the system design of the HP 5890A Gas Chromatograph. More recently, he did the printbar design for the HP 256X Printer. He is named the inventor on three patents on modulated fluid detection of thermal conductivity. John lives in Eagle, Idaho, is married, and enjoys outdoor activities, including hiking, all kinds of skiing, and bicycling. He says he and his wife are also "slowly finishing a house we can't afford."

9 — Low-Cost, High-Reliability Printer

Ben B. Tyson



Ben Tyson studied product design at Stanford University, earning a BS degree in 1976 and an MS degree in 1977. He has been at HP since 1977 and has specialized in impact printer design. He followed the HP 2563A Line Printer from product design to production engineering.

Ben lives in Eagle, Idaho, is married, and has two daughters. He assists in teaching science in local elementary schools and enjoys tennis as well as making and playing musical instruments.

Jeffrey M. Lantz



Jeff Lantz is a native of San Francisco, California and a graduate of California Polytechnic State University at San Luis Obispo (BSME 1979). At HP's Boise Division since 1979, he was a production engineer on the HP 2608A Printer and HP 7970 Tape Drive.

He also contributed to the design of the platen and flexure system for the HP 2563A Line Printer. Jeff lives in Meridian, Idaho, is married to another HP engineer, and has one child. Outside of work, he enjoys cross-country skiing and bicycling.

13 — Mechanical Design

Daniel D. Wheeler



Born in Lexington, Nebraska, Dan Wheeler received a BSME degree from the University of Nebraska in 1981. He came to HP the same year and has contributed to the development of the HP 2565A and HP 2566A Printers. Dan lives in Boise, Idaho, is married, and is interested in flying. He is restoring a 1946 J-3 Piper Cub and also enjoys skiing, basketball, and racquetball.

Peter Gysling



Pete Gysling was born in Minneapolis, Minnesota and is an alumnus of the University of Minnesota (BSME 1979). After coming to HP in the same year, he contributed to the development of the HP 2608S, HP 2565A, and HP 2566A Printers and is currently involved in production engineering work for the 2565A and the 2566A.

His work has resulted in two patent applications, one on a passive paper stacker and the other on a tractor positioning system. Pete lives in Boise, Idaho and is interested in motorcycling, camping, remodeling old houses, and ice hockey. He also enjoys driving his four-wheel-drive pickup truck.

George V. McIlvaine



Born in Boston, Massachusetts, George McIlvaine received a bachelor's degree from the U.S. Military Academy in 1972. He served as a captain in the U.S. Army and continued his education at Stanford University, from which he received an

MSME degree in 1979. He has also completed an MBA degree at Boise State University (1984). After joining HP in 1980, he worked as a production engineer on the HP 7976A Tape Drive and on the HP 2608A Line Printer. Later he was an R&D project manager for the HP 2565A and HP 2566A Printers and is now an engineering services manager. His work has resulted in a patent application for a material handling device. He lives in Boise, Idaho with his wife and three children. He and his wife are sponsoring their second foster child with the Christian Children's Fund and his leisure activities include racquetball, aerobic exercise, and skiing.

Stephen L. Testardi



Steve Testardi was born in Abbington, Pennsylvania and studied at the Virginia Polytechnic Institute, from which he received a BSME degree in 1980. After coming to HP's Boise Division the same year, he worked on the resonant printbar system and lower casting

design of the HP 2566A Line Printer. He is also named coinventor on a patent application on the printbar system. He is presently doing work on impact hammers. Steve is a resident of Boise, Idaho and regularly gives demonstrations on science and engineering at a local elementary school. He likes backpacking, racquetball, and photography and is learning to play the guitar.

18 — Electronics and Firmware

Donald K. Wadley



At HP since 1976, Don Wadley is currently a project manager for a future product. He contributed to the design of the HP-IB controller for the HP 7970 Tape Drive, was a project leader for the controller on the HP 7976A Tape Drive, and worked on the HP

2563A Line Printer. Don was born in Milwaukee, Wisconsin, attended the University of Wisconsin at Milwaukee, and earned BSEE and MSEE degrees in 1975 and 1976. He is interested in manipulator research and did some work on manipulators for the Alvin submarine at the Woods Hole Oceanographic Institution.

Philip Gordon



Phil Gordon came to HP's Data Systems Division in 1972 and has contributed to the development of the HP 1000 M-Series Computers and to the design of the processor for the HP 1000 E-Series and F-Series. After a transfer to the Boise Division, he was a design en-

gineer and project manager for the HP 2680A Printer. Recently, he contributed to the logic design of the controllers for the HP 256X Printers and designed the circuits and artwork for the VLSI component. He is named inventor on two patents related to processor and shift register design. Phil was born in Los Angeles, California and is currently a resident of Boise, Idaho. He received a BSEE degree from the University of California at Berkeley in 1972 and an MSEE degree from Stanford University in 1980.

Phillip R. Luque



At HP since 1973, Phil Luque first worked in the Santa Rosa Division on the receiver portion of the HP 8754A Network Analyzer. After a transfer to the Boise Division, he contributed to the design of the analog electronics of the HP 2631 Printer and to the design of

the power supply for the HP 2563A Line Printer. He was also a production engineer for the 2563A. He is named coinventor on a patent application on the encoder for the 2563A. Phil is a native of Boise, Idaho and an alumnus of Brigham Young University (BSEE 1972 and MEEE 1973). He now lives in Boise, is married, and has five children. He teaches science at a local elementary school and is active in church work. He enjoys folk dancing and astronomy.

23 — Printer Command Language

David L. Price



A development engineer at HP's Boise Division, Dave Price has contributed to firmware design for the HP 2608S and HP 2563A Printers. He is a lifelong resident of Idaho who was born in Pocatello and educated at the University of Idaho

(BSEE 1980). He now lives in Boise, is married, and has two children. His leisure interests include softball, backpacking, and skiing.

Ernest F. Covelli



At HP's Boise Division since 1980, Ernie Covelli was born in Azusa, California and attended California State Polytechnic University at Pomona, from which he earned a BSCS degree in 1980. At HP, he has contributed to the enhance-

ment, testing, and support of the HP 2680A Printer and the HP 2688A Page Printer. He has also worked on formatter testing and specifications for the HP LaserJet Printer. A resident of Boise, Idaho, he likes hiking, camping, all types of skiing, swimming, golf, and gardening.

Von L. Hansen



At HP's Boise Division since 1976, Von Hansen is the project manager for electronic data processing and office printer controllers. He was responsible for the controllers for the HP LaserJet Printer and for the HP 2566A Printer. Von was born in Logan, Utah and

attended Utah State University (BSEE 1976) and Stanford University (MSEE 1980). He lives in Boise, Idaho, is married, and has four children, including a set of twins. He is a scoutmaster in the Boy Scouts of America and is interested in fly-fishing, backpacking, skiing, and racquetball.

27 — Native Language Support

Harry E. Kellogg



Harry Kellogg came to HP in 1976 after completing undergraduate degrees in Greek at Stanford University (1969) and in mathematics at the University of California at Berkeley (1971) as well as an MS in mathematics at the State University of New York at

Buffalo (1976). At HP he worked on various internal projects and after a transfer to Germany contributed to financial accounting software for the HP 3000. Now a member of the Computer Systems Division, he is Native Language Support project manager for the HP 3000. Harry was born in Chicago, Illinois and now lives in Monta Vista, California. He is married and has two children. He is a member of the ACM and a coach for a youth soccer league. His other interests are singing, swimming, and reading.

Jonathan E. Bale



A native of Cleveland, Ohio, Jon Bale was educated at the University of Colorado (BA Mathematics, 1968) and Princeton University (MSEE, 1969). He joined HP in 1969 and has since contributed to a number of software design and development projects for the

HP 3000. He was a member of the original design team for the Image data base manager and has worked in the Netherlands as a customer support engineer and in England as a systems engineer. More recently, he worked on standards for European language support and was project manager for HP 3000 Native Language Support. He now coordinates NLS development activities for all HP computer products. Jon lives in San Jose, California with his wife and two children and enjoys bicycling, photography, and travel. He also claims that one of his hobbies is "reading HP Journal biographies."

Native Language Support for Computer Systems

NLS for the HP 3000 and other HP computers provides hardware and operating system facilities that make application programs easy to translate into other languages.

by Jonathan E. Bale and Harry E. Kellogg

SUPPOSE that someone within your company, but in another country where another language is spoken, has written a very good computer program. You would like to provide this program to users in your own country, but you know that they will not understand many of the conventions or the language of the country in which it was written. The program needs to be *localized* for your country before it can be useful there. What kinds of things do you need to be concerned about?

First of all, of course, there is the language. All text that is part of the program, such as menus, error messages, a help facility, and so on, needs to be translated from the original into your native language. But that is not all. There are other aspects of the dialogue the program carries on with its user that must be considered, such as the format in which dates or numbers are entered or displayed. Also, internal processing of data, such as sorting and upshifting (capitalizing), may need to be localized to meet local conventions or requirements.

How easy is it to localize all of these features? It depends on how the original program was written. If no thought was given to the possibility that the program might be localized for another country, then it is likely that error messages, the format of dates, and the rules for upshifting, for example, are part of the source code of the program. The program can be localized only by changing the source, that is, by rewriting parts of it. This makes the localized version a *new program*. Not only is it a great deal of work to find the appropriate places, decide on and make the changes, recompile, link, and retest the new program, but this also raises the possibility of introducing new bugs into the program, and it greatly complicates its support. If a user reports a bug, does it get referred to the group that wrote the original version of the program, or to the group that localized the version being used?

If some thought was given to the possibility of the program being localized, then it may be considerably easier. However the original effort to make the program easy to localize may have represented a substantial fraction of the total design and programming time. For example, in the September 1984 Hewlett-Packard Journal, Wilson and Shaw¹ describe what the designers of HP office software have done to make it possible for other countries to localize the software without having to modify any source code.

So that each application doesn't have to develop its own

way of flexibly handling language-dependent features, the concept of native language support (NLS) has been developed by a number of cooperating Hewlett-Packard divisions. NLS is an internal set of facilities, both hardware and software, that let application programs executing on a computer system have a natural local look to a user in any country, including local language text and manipulation of data according to local usage. NLS is to be distinguished from localization, which is an external effort to make an application written in one country perform appropriately in another. Localization is much easier if application programs have been written to make use of native language support facilities. This relationship is summarized in Fig. 1.

The native language support that has been implemented recently on several HP computer systems (HP 3000, HP 1000, HP 150) makes software applications easier to localize by providing language- or country-dependent information, as well as the tools to use this information, as part of the computer system itself. NLS is typically part of the operating system, but may also be embedded within processor hardware or peripherals where appropriate.

The application programmer uses these facilities in programming the application, at little extra cost compared with conventional programming. They serve to separate from the program code those aspects of the application that vary from one language to another or from one country to another. Country Software Centers (or other local groups) then localize the application for their own countries and/or languages. At this point localization usually requires only translation of text (prompts, commands, error messages, etc.) into the local language.

The rest of this article describes the components of native

Who	Firmware/OS Programmer	Applications Programmer	Software Localizer
What	Provides native language support facilities	Uses NLS features in program code	Adjusts product as required for local use

Fig. 1. The boxes show the relationship between native language support, which is provided by the firmware or operating system and used by the applications programmer, and localization, which is done by the software localizer. Localization is made much easier, and can often be limited to translation of text, if native language support features have been used.

ROMAN8 CHARACTER SET (USASCII PLUS ROMAN EXTENSION)

				b ₈	0	0	0	0	0	0	0	0	1	1	1	1	1	1	1	1
				b ₇	0	0	0	0	1	1	1	1	0	0	0	0	1	1	1	1
				b ₆	0	0	1	1	0	0	1	1	0	0	1	1	0	0	1	1
				b ₅	0	1	0	1	0	1	0	1	0	1	0	1	0	1	0	1
					0	1	2	3	4	5	6	7	8	9	10	11	12	13	14	15
b ₄	b ₃	b ₂	b ₁																	
0	0	0	0	0	NUL	DLE	SP	0	@	P	'	p				—	â	Å	Á	Ï
0	0	0	1	1	SOH	DC1	!	1	A	Q	a	q			À		ê	î	Â	þ
0	0	1	0	2	STX	DC2	"	2	B	R	b	r			Â		ô	ø	ã	
0	0	1	1	3	ETX	DC3	#	3	C	S	c	s			È	°	û	Æ	Ð	
0	1	0	0	4	EOT	DC4	\$	4	D	T	d	t			É	Ç	á	å	đ	
0	1	0	1	5	ENQ	NAK	%	5	E	U	e	u			Ë	ç	é	í	Ï	
0	1	1	0	6	ACK	SYN	&	6	F	V	f	v			Ï	Ñ	ó	ø	Ï	—
0	1	1	1	7	BEL	ETB	'	7	G	W	g	w			Ï	ñ	ú	æ	Ó	¼
1	0	0	0	8	BS	CAN	(8	H	X	h	x				ı	à	À	Ò	½
1	0	0	1	9	HT	EM)	9	I	Y	i	y				ı	è	ı	Õ	¾
1	0	1	0	10	LF	SUB	*	:	J	Z	j	z			^	œ	ò	Ö	õ	¸
1	0	1	1	11	VT	ESC	+	;	K	[k	{			ˆ	¸	ù	Ü	Š	«
1	1	0	0	12	FF	FS	,	<	L	\	l				˜	¥	ä	É	š	■
1	1	0	1	13	CR	GS	-	=	M]	m	}			Û	§	ë	Ï	Ú	»
1	1	1	0	14	SO	RS	.	>	N	^	n	~			Û	ſ	ö	ß	ÿ	±
1	1	1	1	15	SI	US	/	?	O	_	o	DEL			¸	ç	ü	Ô	ÿ	

Fig. 2. The Roman8 character set table. This is the most commonly used of the extended 8-bit character sets that provide the additional characters necessary to support languages other than American English.

language support and how application programs can use them.

Character Sets

Support of native languages on HP computers is dependent on the use of so-called extended (in most cases, 8-bit) character sets. The original character set supported by Hewlett-Packard hardware and software was USASCII, a 128-member set of characters designed to support American English text. Each character within a USASCII-encoded stream of data occupies one byte (eight binary digits or bits), although the code assignments for these characters are densely packed into the range of 0 to 127, which means that the value of the high-order (most-significant) binary digit is always zero. For this reason, USASCII is referred to as a 7-bit code.

Because an 8-bit byte fundamentally has the ability to contain 256 unique values, it is possible to represent character sets larger than USASCII within a one-byte encoding scheme. This is the approach that has now been taken within HP for the encoding of characters required by languages other than American English. These new character sets have the following features:

- Each is a superset of USASCII. Therefore, all USASCII characters are available, and have their normal code values.
- All new characters (with code values greater than 127) are available to serve the needs of non-U.S. languages.

- It is often possible to support multiple languages unambiguously with a single set. This can be of great advantage when data is exchanged between countries.

For native language support, each language to be supported is associated with a known 8-bit character set. There are currently two such character sets that are widely supported by native language support hardware and software: Roman8 for Western-European-derived languages (see Fig. 2), and Kana8 for the support of Katakana, a Japanese syllabary that allows Japanese words to be written phonetically rather than with pictographic characters.

Peripherals and Applications

Obviously, the support of native languages depends not only on the software's ability to recognize and manipulate native language characters, but also on the ability to input and output these characters. Most HP terminals, plotters, and printers are capable of handling one or more of the currently defined 8-bit character sets.

The use of 8-bit character sets for NLS implies that in character data, all bits of every byte have significance. Application software must take care not to tamper with the eighth (high-order) bit. For example, it was previously common in data communications software to use the eighth bit as a parity bit to check for correct transmission of data, or in word processing software to use the eighth bit to indicate whether a character should be underlined when it is printed. Alternative methods must be found to ac-

comply purposes of this nature. Also, no differentiation should be made between characters having the eighth bit on and those having it off, because all are characters of equal status in an extended character set.

Languages

In the recent native language support (NLS) project for the HP 3000 Computer, we defined 14 supported languages as a part of the MPE operating system (see Fig. 3). Each language is identified in the system by a unique language name and language number.

The definition of each of these languages includes a number of characteristics of that language. Some of these are really language related in the traditional sense, such as day and month names and lexical order (collating sequence). Other characteristics associated with a supported native language are really country or local custom dependent, such as currency symbols and date formats. Another group of characteristics is data processing oriented—for example, the conversion algorithm between the HP 3000's character representation (a superset of ASCII) and the EBCDIC used by some other computers.

Within NLS, all of these characteristics—language related, custom dependent, and data processing oriented—are considered to be language dependent. All information and data manipulation available from NLS are based on the application's choice of a language. Thus, for example, NLS maintains not only an English upshifting algorithm, but also an English time-of-day format. In the latter case "English" may be considered to mean "used in England" rather than "of the English language."

In some cases, more than one HP supported language has been introduced for a single natural language. This is done in cases in which there are known differences in one or more of the fundamental language characteristics. For example, the upshifting of accented vowels is handled differently in French Canada and in France. The French drop the accent in the uppercase version; the French Canadians do not. We support this difference by providing separate languages.

Conversely, each of the supported languages may be considered a language family, potentially usable in multiple countries. Thus, the language German is usable in Germany, Austria, Switzerland, or anywhere else it is desired.

A list of the characteristics of a supported language is shown in Fig. 4. An interesting example, the collating sequence or lexical ordering of a language, is discussed in the box on page 30. These characteristics were defined by the HP 3000 NLS project with the help of HP Software Centers in the various countries. Many of them can be modified by the user.

Intrinsics

NLS provides system library routines, or intrinsics as they are called on the HP 3000, to access or to use the language-dependent information. Each intrinsic accepts a language number parameter in addition to whatever other parameters it needs. This language number determines which language-dependent information the intrinsic accesses and how it works on any data provided.

An application program can use these intrinsics to replace traditional programming techniques that may be

biased towards American English usage. For example, to upshift a string of characters, a program has traditionally subtracted 32 from the code value of each character in the range a to z. This is because 32 is exactly the difference in the codes of the corresponding uppercase and lowercase characters within the ASCII code table. For example, the internal code for the character n is 110; for the character N it is 78. Such a technique no longer works with the character é of the Roman8 character set since for historical reasons é could be placed neither within the range a to z, nor at a distance of exactly 32 either from E (for French) or from É (for Canadian French and most other languages supported by Roman8). The application instead calls the NLSCANMOVE intrinsic, requesting upshifting and passing it a language number. NLSCANMOVE passes back a string that has been upshifted correctly for the requested language.

Similarly, instead of calling the old intrinsic FMTDATE to format a dateline in the traditional HP 3000 format, an application calls NLFMTDATE, which is called in the same way except that it takes the extra parameter langnum. NLFMTDATE formats the dateline in a language-dependent fashion. This call might produce "Sun, Oct 7, 1984, 2:42 PM" if langnum were 1 (American), but "Sö 7 Okt 1984, 14.42" if langnum were 13 (Swedish).

In addition to the 14 real languages supported by the first release of NLS for the HP 3000, a dummy language called Native 3000 (language number 0) has also been created for backward compatibility. The characteristics of Native 3000 may be thought of as "the way it used to work." For example, a request to NLSCANMOVE to upshift for langnum 0 will affect only the characters a through z and in effect subtract 32 from each occurrence. A call to NLFMTDATE with langnum 0 will have the same result as a call to the old FMTDATE intrinsic.

Application Message Catalogs

A localizable program has as one of its characteristics the attribute that no text (prompts, commands, messages, menus) is stored in the source code. This allows the text material to be translated easily (as part of the localization step) without modifying the source code. For the NLS project we created a new application message facility with the following features, which were felt to be essential for native language support:

- Accessible via intrinsics callable from all of the major programming languages, so that all types of programs

American
Canadian French
Danish
Dutch
English
Finnish
French
German
Italian
Norwegian
Portuguese
Spanish
Swedish
Katakana

Fig. 3. The languages supported by the first release of NLS for the HP 3000.

Native Language Collating Sequences for Europe

One of the attributes of languages that varies from one to another is the collating sequence or lexical ordering of characters and words that may appear in that language. Alphabetical order may be considered the starting point for this, but it must be extended to take into account numbers, punctuation marks, foreign characters, and so on. In that characteristic of a supported native language known as its collating sequence, native language support for the HP 3000 is able to provide the accepted dictionary ordering for all of the native languages supported.

This is a considerable improvement over traditional computer collating, which orders characters in the order of their internal representation. This happens (not quite by chance) to order the English letters A through Z in the correct order, but it does not provide collating of lowercase a between A and B, nor does it handle such European requirements as the German ß, which is ordered in German dictionaries as though it were ss, or Spanish words beginning with ch, which are found after all other words beginning with c, since ch is treated in Spanish as a single letter distinct from c. Nor does it satisfy the requirements of the French that the accents on vowels be ignored in collating words, unless the words are identical except for accent, in which case a rigid order of accent marks is prescribed.

To handle these and other requirements of supported languages, the definition of a collating sequence and the collating algorithm provide the following options:

1. Reordering the collating of characters. For example, a and â can be collated between A and B even though their internal representations do not lie between A and B.
2. Two-for-one substitutions. A single character can be collated as if it were two characters. For example, the ß from German is collated for all Roman8 supported languages as though it were ss.
3. One-for-two substitutions. A pair of characters can be collated as if they were a single character. For example, in Spanish the letter pair ch is collated as if it were a single letter, distinct from either c or h, and collating between c and d.
4. Character priority. This allows differences between two characters to be ignored (the two are considered equal), unless all subsequent characters in the strings being compared are also equal (or treated as equal), in which case priorities assigned to the otherwise equal characters are compared to break the tie. The typical use of this option is for case (upper versus lower) and accent (vowels with and without) differences. For example, for all of the languages supported by the Roman8 character set the e vowels (upper or lower case, with or without accent) are treated as equal except for priority; their priority order is: E e É é Ê ê Ë ë.
5. "Don't care" characters. It may be appropriate to ignore certain characters in comparing strings. The result will be the same as if such characters were simply removed from all strings containing them. This option is not employed in any of the currently supported languages on the HP 3000. However, it will be necessary for the definition of some languages for which future support is planned.

One of the principles followed in the definition of native language collating sequences is that, for a given character set, every character in that character set may appear in data for any language supported by the character set. For example, the character ä might appear in an American data base, even though, strictly speaking, it is not an English letter. This makes practical sense, because terminals and printers are implemented to support a character set, not a language. Therefore, it is possible for any of the characters to get into data. It also makes data processing sense, because even if a certain character doesn't exist in a certain language, it may still occur in names, foreign addresses, and so on. It is very useful to be able to address a letter to Germany correctly, even when it originates in Italy.

Another principle followed is that a character that does not usually appear in a language should be collated where users of that language might be expected to look for it. For example, the æ character, which actually collates after z in Danish and Norwegian, is collated as if it were ae in all other languages, using the two-for-one substitution option.

Application of these principles to the definition of the collating sequence for the Spanish language results in a sample list of words being sorted as follows:

```
covert
charro
forest
Forster
Förster
fortify
nascent
naß
nasty
```

In any other Roman8 supported language but Spanish, the first two words would be exchanged, but otherwise the order would be the same.

These collating sequence principles are implemented in an algorithm in the routine NLCOLLATE, which may be called from any program. A program that wants to compare two character strings to order them alphabetically in a list such as that above would traditionally have used a programming language construct like:

```
IF string1 <string2, (stringlength) THEN ...
```

which is typically compiled to execute a hardware "compare bytes" instruction. Such an instruction orders characters only according to their internal representation. This can now be replaced by the following call:

```
NLCOLLATE (string1, string2, stringlength, langnum, result);
IF result < 0 THEN ...
```

which performs correctly for whatever the current language number happens to be. Considerable effort was invested in optimizing the algorithm that implements this collating sequence, so that users of native language collating sequences pay only a minimal performance penalty.

can use it.

- Efficient in its storage of text to minimize the disc space used by any particular message catalog. This makes it practical for an application to have text available and on-line in several languages at one time.
- Fast in accessing and displaying text, so that its use is not discouraged by poor response time. This is achieved

by a two-layered directory of messages with caching of the most recently used portions, so that access of any message requires at most two disc reads, and usually only one.

- Flexible in meeting the requirements of different languages for storing and displaying text, so that realistic translations are possible for all languages. This is

Language name, number
 Character set
 Character definitions (uppercase, lowercase, numeric, etc.)
 How each character is upshifted
 How each character is downshifted
 EBCDIC conversion tables (to and from)
 Collating sequence table (correct sorting order)
 Decimal delimiter, thousands separator (for numeric formatting)
 Currency sign, abbreviation, and position (for monetary formatting)
 Month names and abbreviations
 Weekday names and abbreviations
 External date format
 External time-of-day format
 External custom (short) date format
 Words for "yes" and "no"
 Additional country or language specific information as required

Fig. 4. Characteristics associated with a supported native language.

achieved with variable-length message records and with numerical parameters that allow the variable portions of a message (inserted at execution time) to appear in any order in the message.

- Easily maintained message sources. A merging of a master and a maintenance message file (such as has long been available for compilers of source code) is built into the utility program that builds message catalogs. This way, when the original language messages change, it is easy for the localizer to isolate and translate only the changed portions and to recreate a new translated catalog quickly.

An application would use this message catalog facility to replace traditional messages hard-coded within the program as follows. Suppose that a Pascal program would normally have contained the line:

```
WRITELN ( 'The data set ', dataset_name, ' does not belong',
         ' to the data base ', database_name, ' ');
```

This statement has the effect of writing a line containing some constant English text with two variable strings (dataset_name and database_name) included. To make this function language independent, a message catalog is prepared in which, let us say, in message set 7 is found the following message number 23:

```
23 The data set !1 does not belong to the data base !2.
```

In the program the WRITELN statement shown above is simply replaced by:

```
CATREAD ( cat_index, 7, 23, n_error, , dataset_name,
         database_name );
```

where cat_index is a pointer, which was returned at the beginning of the program when the message catalog was opened, and n_error is a parameter, to which error values may be returned if the call is unsuccessful. The German version of the same catalog might contain message number 23 translated as follows:

```
23 Die Datenbank !2 enthält den Datensatz !1 nicht.
```

Since the order of the symbols !1 and !2 has been reversed, the data base name will appear first in the message,

and the data set name will appear later. This order allows a more natural expression of the message in German.

Subsystems

In addition to these modifications to the operating system, NLS for the HP 3000 also modified the most commonly used subsystems: the data base manager (Image) and its inquiry processor (Query), the screen handler (VPlus), the indexed sequential file manager (KSAM), the file copier (FCopy), the sort package (Sort-Merge), and one of the compilers for the programming language COBOL.

In Image, certain information inside data bases is linked in sorted order based on the value of a field in the data. This sorted order may now be that of a native language. Image accomplishes this by calling the NLCOLLATE intrinsic instead of doing a byte comparison on the fields to be compared. In the same way, the Sort and Merge programs, and the sorting intrinsics that they and other programs use, now call NLCOLLATE to compare character keys of records being sorted.

The screen handler VPlus does built-in edits of user input. When asked to check a field for valid numeric input, it can now vary its results depending on a language. The input "1.234,56" is, for example, perfectly valid if the language is Dutch, but not if it is American. VPlus determines this based on the valid decimal indicator and thousands separator for the language.

The file copier FCopy can be requested to translate characters from ASCII to EBCDIC (or vice versa) while it is copying a file. This is also language sensitive now, since FCopy calls the new NLTRANSLATE intrinsic to be sure that the translation is into the correct version of EBCDIC, which varies from country to country. Previously, FCopy used a built-in table based on the American version of EBCDIC

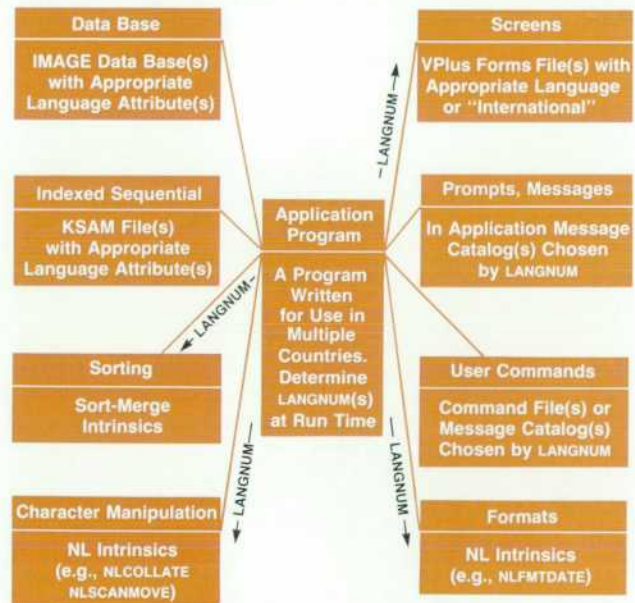

Fig. 5. The multilingual application program, using the facilities provided by native language support, can be used on the same computer at the same time by users with different native languages.

only.

Language-dependent processing in all of these subsystems, or in any application, can be explicitly requested via new commands or keywords. But it can also be triggered automatically via one of several types of default languages available at any time from the operating system. For example, Query reporting from an Image data base is sensitive to the user interface language of the Query user. But Image sorted chains depend on the data manipulation language associated with the Image data base. Of course, these various default languages will often be all the same. But other examples already exist in the current HP product line in which they differ. In HPWord, for example, the distinction is maintained between the interface language of the user (used for error messages and prompts) and the data language of the document (used, for example, for automatic hyphenation).

The Multilingual Application

Fig. 5 illustrates a program that has been designed and implemented to use the facilities provided by native language support. Such a program can be called a *multilingual* program because it can be used on the same computer at the same time by users with different native languages. Such an application selects its language(s) at run time based on information about the system, the user, the application, or the data to be processed. For example, it could have multiple copies available (one per language) of a message catalog and a screen forms file. Systematic choices of names for the different local versions make it possible for the application to open the correct files based on the language of the user.

The application also opens any needed data bases or data files, which may or may not depend on language choice. Text to be displayed is fetched from the message catalog or screen forms file. The appropriate language numbers are passed to the various native language intrinsics to perform functions that are language dependent. These include editing or formatting of data exchanged with the user, such as dates, times, and numbers. They also include internal manipulations such as upshifting, scanning, character comparisons, and sorting. The same program code now exhibits multiple personalities depending on the user and the envi-

ronment.

Of course, not all functions that vary from one language to another or from one country to another are provided by HP native language support. For example, tax calculation rules are usually country specific (or even more local), and rules for word hyphenation are language specific. Functions such as these are considered to be in the domain of the application, and are beyond the scope of NLS (so far). Nevertheless, applications that perform such functions should implement them in such a way that they are easily localized.²

Other Systems

Similar development has recently produced native language support for the HP 1000 and the HP 150 Computers. Other projects are under way to provide native language support in future generations of computer products, to support new languages and character sets, and to support additional characteristics of native languages.

Acknowledgments

We would like to pay tribute to pioneering work in this field on the HP 9845 Desktop Computers and the HP 250 Computer. The changes to the HP 3000 MPE operating system were carried out by the authors, by Computer Systems Division engineers Geoff Ralston and Larry Cargnoni, and by six engineers on loan from HP organizations abroad: Franz Bradl of HP Germany, Frédéric Chambardon of HP France, Joon-Keun Choi of Samsung-Hewlett-Packard, Antoni Drudis of HP Spain, Keith Harrison of HP United Kingdom, and Jaap Vegter of HP Netherlands. Credit is also due the authors of previous versions of the external specifications for the HP 3000, particularly Jon Cohen of Computer Systems Division. The definition and coding of subsystem changes were aided and in some cases entirely implemented by a host of people from many different Hewlett-Packard divisions.

References

1. H. Wilson and M.J. Shaw, "Designing Software for the International Market," *Hewlett-Packard Journal*, Vol. 35, no. 9, September 1984.
2. P.R. Smit, "A Hyphenation Algorithm for HPWord," *ibid.*

Hewlett-Packard Company, 3000 Hanover Street, Palo Alto, California 94304

HEWLETT-PACKARD JOURNAL

June 1985 Volume 36 • Number 6

Technical Information from the Laboratories of
Hewlett-Packard Company

Hewlett-Packard Company, 3000 Hanover Street
Palo Alto, California 94304 U.S.A.

Hewlett-Packard Central Mailing Department

Van Heuven Goedhartlaan 121

1181 KK Amstelveen, The Netherlands

Yokogawa-Hewlett-Packard Ltd., Suginami-Ku Tokyo 168 Japan

Hewlett-Packard (Canada) Ltd.

6877 Goreway Drive, Mississauga, Ontario L4V 1M8 Canada

Bulk Rate
U.S. Postage
Paid
Hewlett-Packard
Company

CHANGE OF ADDRESS: To subscribe, change your address, or delete your name from our mailing list, send your request to Hewlett-Packard Journal, 3000 Hanover Street, Palo Alto, CA 94304 U.S.A. Include your old address label, if any. Allow 60 days.