



An RMS-Responding Voltmeter With High Crest Factor Rating



Fig. 1. Hewlett-Packard Model 3400A RMS Voltmeter indicates root-mean-square value of complex waveforms having frequency components within 10 cps to 10 Mc passband. Large crest factor of 10 to 1 enables accurate rms voltage measurements on nearly all waveforms, including impulse noise and narrow pulse trains (see text).

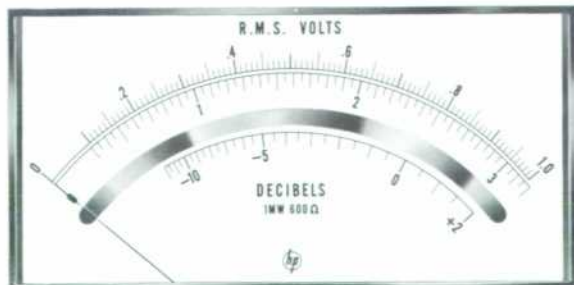

Fig. 2. Temperature-compensated taut-band meter has linear scales individually calibrated for each meter movement on -hp- servo-controlled meter calibrator. Voltmeter can also be obtained with DB scale uppermost.

IN TYPICAL electronics work, measurements of ac voltage are most often made with voltmeters that respond to the average value of the rectified voltage waveform or to the peak. In most cases such measurements are completely satisfactory, as confirmed by the popularity of such voltmeters.

At the same time, however, there are occasions when a measurement based on the true rms value of a voltage is desired. Measurements of electrical or acoustic noise, of low-duty-cycle pulse trains, and of voltages of undetermined waveform are instances wherein an rms-responding voltmeter is valuable.

A new voltmeter has now been developed that both responds to the rms value of the ac waveform and has a high crest factor rating. This rating is the measure of the voltmeter's ability to read the rms value of waveforms that have a high peak-to-rms ratio such as low-duty-cycle pulse trains (see pp. 4, 5).

In other respects the new voltmeter is as convenient to use and has as wide a measuring range as the best average-responding types. Its voltage range extends from 100 microvolts to 300 volts and its frequency range from 10 cps to 10 megacycles. Its crest factor rating is 10:1 which enables it to read at full scale the rms value of pulse trains that have only a 1% duty cycle. At 1/10th of full scale, it will read pulse trains of only 0.01% duty cycle.

SEE ALSO:

- Crest factor, pp. 4, 5
- 7000-hr. Stability curves, p. 6
- U. S. Frequency Standard, p. 7
- hp- Service Seminars, p. 8

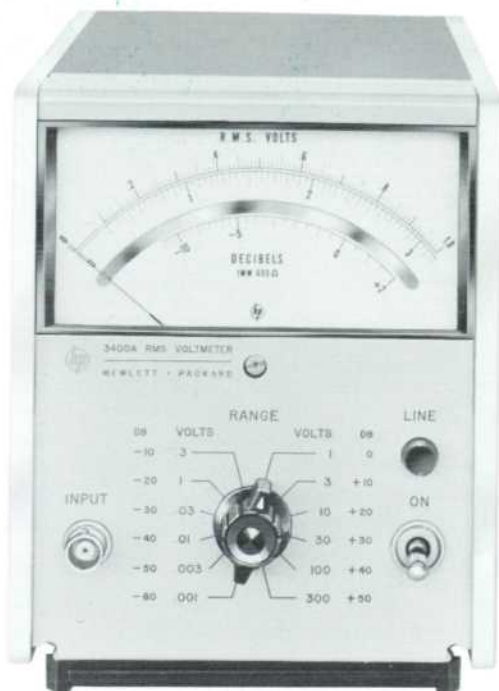

Fig. 3. New *-hp-* 3400A RMS Voltmeter has a 10 megohm input impedance, no zero set control, and a high crest factor with immunity to large overloads. Sensitivity is such that usable indications are obtained down to 100 microvolts.

MEASURING RMS CURRENT

Besides the general uses mentioned above, the new rms voltmeter may be used as an AF or RF power meter by connecting it to monitor the voltage applied to resistive loads. In this way power levels as low as 17 picowatts (17×10^{-12} watts) in 600 ohms can be measured.

In addition, the new voltmeter is valuable as an rms milliammeter or ammeter. Measurements of these currents can be made by using the voltmeter with the *-hp-* clip-on current probes.^{1, 2} These probes merely clip around the current conductor and provide an output voltage that is proportional to the measured current and of identical waveform. Currents of well below a milliampere and up to tens of amperes can be thus measured.

RMS AC-DC CONVERTER

Since it is provided with a dc output which is proportional to the meter deflection, the new voltmeter can be used as a linear rms-ac-dc converter. The dc output can then be used to drive a digital dc voltmeter and/or a dc recorder where an analog record is desired. Further, the voltmeter provides a conversion gain of up to 60 db on its most sen-

sitive range. This can be reduced in 10 db steps to -50 db on the least sensitive range.

The dc output is also useful for closing control loops where it is desired to hold constant the rms value of a given signal.

External loading of the dc output does not affect the meter accuracy so that both meter and dc output can be used simultaneously.

DESIGN APPROACH

RMS sensing in the new voltmeter is accomplished by a high-quality vacuum thermocouple. Thermocouples traditionally have been used as rms ac to dc converters where high accuracy and wide bandwidths were required. Other methods have been preferred where possible, however, because of certain disadvantages in most measuring schemes involving thermocouples. These difficulties include sluggish response, susceptibility to burnout, and a voltage transfer that varies with temperature. These disadvantages have been overcome in the Model 3400A by the proper design of the ac thermocouple drive circuitry and by use of a self-balancing bridge configuration, as shown in Fig. 4.

A block diagram of the 3400A voltmeter is shown in Fig. 5. The self-balancing thermocouple bridge circuit is preceded by attenuators and amplifiers.

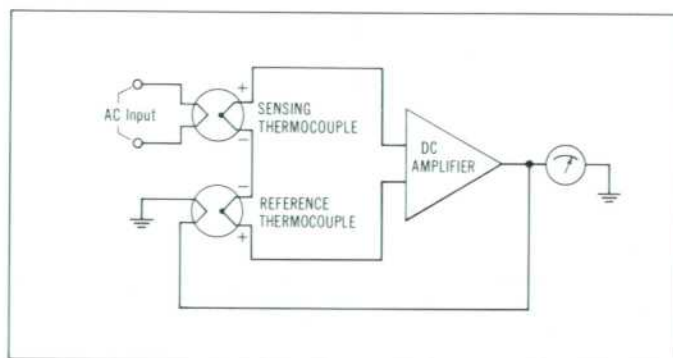

Fig. 4. Basic principle of RMS voltmeter operation. Two matched thermocouples in common thermal environment are connected with outputs subtracting. Resulting difference voltage, amplified and returned to heater of reference thermocouple, thus "tracks" heating power of ac input voltage and is used as indicator of rms ac input.

¹ Charles O. Forge, "A New Clip-On Oscilloscope/Voltmeter Probe for 25 cps-20 Mc Current Measurements," *Hewlett-Packard Journal*, Vol. 11, No. 11-12, July-Aug., 1960.

² John G. Tatum, "A Clip-On Current Probe for Wideband Oscilloscope Measurements," *Hewlett-Packard Journal*, Vol. 15, No. 2, Oct., 1963.

The thermocouple bridge establishes an equivalence between the rms value of the input signal and a dc feedback voltage in the following manner. The two matched thermocouples are connected with output voltages subtracting. Power applied to the heater of the input thermocouple generates a dc unbalance signal in the thermocouple outputs which is amplified and applied to the heater of the feedback thermocouple. The increased dc output from this thermocouple reduces the unbalance signal.

Since the dc amplifier gain is high, the unbalance signal remains very close to zero ($< 25 \mu\text{volts}$) at all times. The dc voltage applied to the feedback thermocouple therefore is proportional to the rms value of the voltage applied to the input thermocouple. The panel meter monitors the feedback dc voltage to provide the indication of the rms value of the input voltage.

Any parameter variations common to both thermocouples do not affect accuracy because of the high loop gain and the bridge configuration. Since the thermocouples are subject to the same thermal history, the voltmeter reads a new voltage accurately even while the thermocouples are settling to a new thermal level. Relatively fast response ($< 2 \text{ sec}$) is characteristic of this voltmeter.

The dc amplifier is a high-gain chopper amplifier employing a photoconductor modulator and demodulator. AC feedback around the amplifier reduces sensitivity to component variations in the modulator, demodulator, and chopper amplifier.

Tandem emitter-followers provide a low resistance drive to the meter circuit and to the feedback thermocouple heater, in addition to supplying the dc output at the rear panel through a 1 kilohm resistor. The resistor determines the output impedance and also isolates the out-

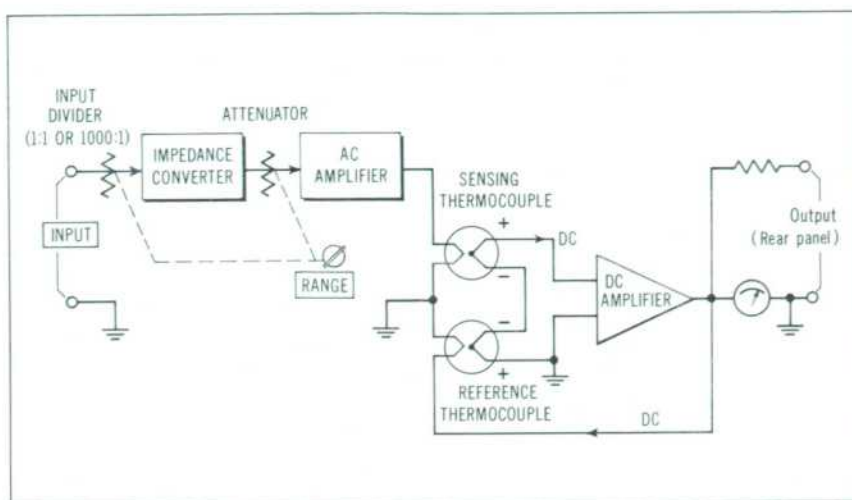

Fig. 5. Block diagram of -hp- Model 3400A RMS Voltmeter.

put so that meter accuracy is independent of output loading. The output amplitude, corresponding to full scale meter deflection, is 1 volt into an open circuit or 1 ma into a short circuit.

INPUT CIRCUITRY

The signal at the input terminals initially is attenuated, if necessary, by an accurate, high-impedance attenuator capacitively compensated for high-frequency response. The signal is then applied to an impedance converter which is a unity-gain, two-stage feedback amplifier. The input Nuistor of the impedance converter presents a high impedance ($> 300 \text{ megohms}$) to the input circuitry while the transistor output stage provides a low source impedance ($< 4 \text{ ohms}$) for the following attenuator. The circuit has a wide dynamic range and is able to withstand large overloads.

The second attenuator, which follows the impedance converter, has a range of 50 db in 10 db steps. This is a resistive divider network using high quality, non-inductive precision resistors matched to a voltage division accuracy of better than 0.05%. The attenuator output impedance is made constant to avoid undesirable interactions with the input impedance of the main amplifier.

The main amplifier is a five-stage, wideband transistor amplifier that has a large negative feedback factor to assure stability and gain accuracy. The ac loop gain at midband is typically 60 db and, in addition, a dc bias loop holds the transistor operating points within a few tenths of a volt over the entire operational temperature range from 0° to $+55^\circ\text{C}$.

To reduce sensitivity to parameter variations, the phase and magnitude of the overall amplifier loop gain are controlled by a local feedback loop in the forward path. The magnitude of the local feedback increases with frequency with the net result that at gain crossover, there is still some local feedback for gain stabilization.

The main amplifier gain is approximately 50 db and bandwidth is typically from 3 cps to 30 Mc between the $\pm 3 \text{ db}$ amplitude response limits. The output stage is a complementary-symmetry class B amplifier that has the wide dynamic range necessary for high crest factor performance. Protection against thermocouple burnout is achieved by restricting the charge available in the amplifier output coupling capacitors in accordance with the average signal level.

This design approach results in



Fig. 6. RMS values of alternating currents are measured with combination of -hp- Models 456A Current Probe and 3400A RMS Voltmeter. Current Probe sensitivity of 1 mv/1 ma permits voltmeter scales to be read directly as current.

a fast-responding instrument that is accurate and stable, requiring no zero set control, and that measures ac voltages over a wide range of amplitudes and frequencies. Long term reliability is achieved through conservative design and the use of high quality components throughout the instrument.

ACKNOWLEDGMENTS

Members of the 3400A electrical

design team include Harvey M. Fishman, George R. Sinfield and the undersigned. Mechanical design was by Robert W. Kingston. Robert K. Chipman provided product support. In addition, the author would like to express his gratitude to Donald E. Norgaard and Dr. Paul E. Stoff who have made valuable suggestions during the course of the project.

-Gregory Justice

SPECIFICATIONS

-hp-

MODEL 3400A RMS VOLTMETER

RANGE: 12 ranges from 1 millivolt full scale to 300 v full scale in a 1, 3, 10 sequence. -72 to +52 dbm. (Usable indications to 100 μ v.)

FREQUENCY RANGE: 10 cps to 10 Mc.

ACCURACY: Within $\pm 1\%$ of full scale, 50 cps to 1 Mc. Within $\pm 2\%$ of full scale from 1 to 2 Mc. Within $\pm 3\%$ of full scale, 2 to 3 Mc. Within $\pm 5\%$ of full scale, from 10 to 50 cps and from 3 to 10 Mc. (Usable readings to 5 cps and 20 Mc.)

RESPONSE: Responds to rms value of ac waveform at input.

CREST FACTOR (ratio of peak amplitude to rms amplitude): 10 to 1 at full scale; inversely proportional to pointer deflection, e.g., 20 to 1 at half-scale, 100 to 1 at tenth-scale.

MAXIMUM INPUT: 425 v rms.

INPUT IMPEDANCE: 10 megohms shunted by 25 pf.

RESPONSE TIME: Typically < 2 sec. to within 1% of final value for a step change of input voltage.

OVERLOAD PROTECTION: 40 db or 425 v rms, whichever is less, on each range.

OUTPUT: Negative 1 vdc at full scale deflection, proportional to pointer deflection; 1 ma maximum. Nominal source impedance: 1000 ohms.

POWER: 115 or 230 v $\pm 10\%$, 50 to 60 cps, approximately 7 watts.

DIMENSIONS: 5 1/2 in. wide, 6 1/2 in. high, 11 in. deep (1/2 module).

WEIGHT: Net, 7 1/4 lbs.

ACCESSORY FURNISHED: 10110A Adapter, BNC to dual banana jack.

ACCESSORIES AVAILABLE: 11001 Cable, 45 in. long, male BNC to dual banana plug, \$5.50. 10503A Cable, 4 ft. long, male BNC connectors, \$6.50. 11002A Test Lead, dual banana plug to alligator clips, \$7.50. 11003A Test Leads, dual banana plug to probe and alligator clip, \$10.00.

-hp- Model 456A AC Current Probe, 1 mv/1 ma, \$190.00.

PRICE: -hp- Model 3400A RMS Voltmeter, \$255.00.

-hp- Model 3400A-db, with special meter face having db meter scale outermost to permit greater resolution in db reading: \$25.00 extra.

Prices f.o.b. factory

Data subject to change without notice

CREST factor is defined as the ratio of the peak voltage to the rms voltage of a waveform (with the dc component removed). A voltmeter with a high crest factor rating is able to read accurately the rms values of periodic signals that have waveforms significantly different from sinusoidal.

The crest factor of a low duty cycle pulse waveform turns out to be far different than might be presumed from considerations of the peak-to-average ratio. The pulse waveform of Fig. 1, for instance, has a duty cycle of 1% but the crest factor of this waveform is approximately 10, not 100 as might be surmised. For waveforms of this type, the crest factor is nearly equivalent to the inverse of the square root of the duty cycle, as discussed below.

High crest factor performance is not obtained easily. An rms voltmeter with a high crest factor must have amplifiers with sufficient dynamic range to pass signals that have a peak amplitude many times larger than full scale rms value.

A wide dynamic range, however, is not the only consideration. To prevent thermocouple burnout, the amplifier design should include some provision for power limiting. Straightforward amplitude limiting, as can be seen, is not the answer since this would limit the crest factor. The amplifier therefore must be designed with a limit on the voltage-time product so that thermocouple burnout is prevented without restricting the wide dynamic range.

THE SIGNIFICANCE OF CREST FACTOR



Fig. 1

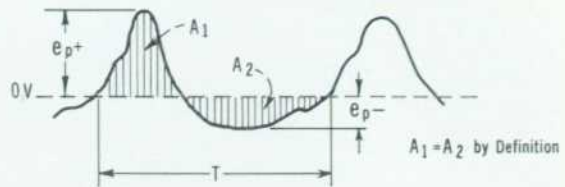

Fig. 2

DERIVATION OF CREST FACTOR

For any waveform (Fig. 2) without dc:

Crest factor, $CF = \frac{e_{p+}}{e_{rms}}$ or $\frac{e_{p-}}{e_{rms}}$, whichever is greater.

$$e_{rms} = \left(\frac{1}{T} \int_0^T e^2 dt \right)^{1/2}$$

Since a pulse train represents an extreme case of a non-sinusoidal periodic waveform, and in some cases is a reasonable approximation of impulse noise, it will be treated here in more detail. For the pulse waveform (Fig. 3):

$$e_a + e_b = e_{pp} \quad (1)$$

$$e_a t_0 = e_b (T - t_0) \quad (2)$$

If duty cycle, D , is defined as:

$$D = t_0 / T$$

Then, $e_b = e_{pp} D$

and $e_a = e_{pp} (1 - D)$ (3)

The rms sum of e_a and e_b , related to e_{pp} by equations 2 and 3, is, after integration:

$$\begin{aligned} e_{rms} &= \left(\frac{e_{pp}^2 (1 - D)^2 t_0 + e_{pp}^2 D^2 (T - t_0)}{T} \right)^{1/2} \\ &= e_{pp} \sqrt{D - D^2} \\ &= e_{pp} \sqrt{D(1 - D)} \end{aligned} \quad (4)$$

Since crest factor, $CF = e_a / e_{rms}$ for values of $0 \leq D \leq 1/2$,

$$\begin{aligned} CF &= \frac{e_{pp} (1 - D)}{e_{pp} \sqrt{D(1 - D)}} \\ &= \sqrt{\frac{1}{D} - 1} \end{aligned} \quad (5)$$

Examples:

$$\begin{aligned} \text{If } D = \frac{1}{100}, \quad CF &= \sqrt{\frac{1}{1/100} - 1} \\ &= \sqrt{100 - 1} \\ &\cong 10 \end{aligned}$$

$$\begin{aligned} \text{If } D = \frac{1}{10,000}, \quad CF &= \sqrt{\frac{1}{1/10,000} - 1} \\ &= \sqrt{10,000 - 1} \\ &\cong 100 \end{aligned}$$

The rms voltage of a pulse waveform with baseline fixed at ground (includes a dc component) is, from Fig. 4:

$$\begin{aligned} e_{rms} &= \left(\frac{1}{T} \int_0^{t_0} e_{pp}^2 dt \right)^{1/2} \\ &= \left(\frac{1}{T} e_{pp}^2 t_0 \right)^{1/2} \\ &= e_{pp} \sqrt{t_0 / T} \\ &= e_{pp} \sqrt{D} \end{aligned} \quad (6)$$

The rms voltage of a pulse waveform with baseline fixed at ground is measured with both an rms voltmeter and a dc voltmeter. Then:

$$e_{rms} = \sqrt{e_{ac}^2 + e_{dc}^2}$$

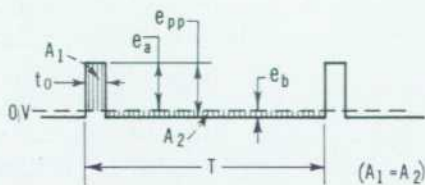

Fig. 3

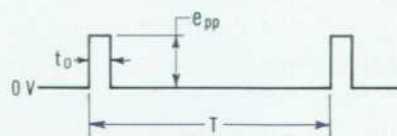
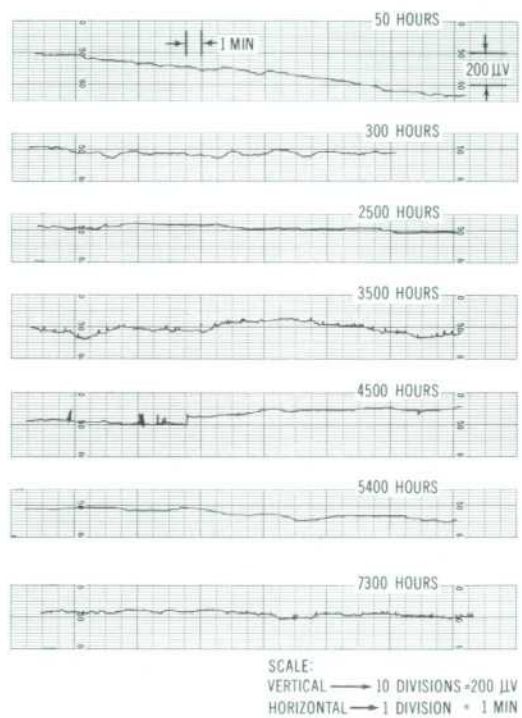
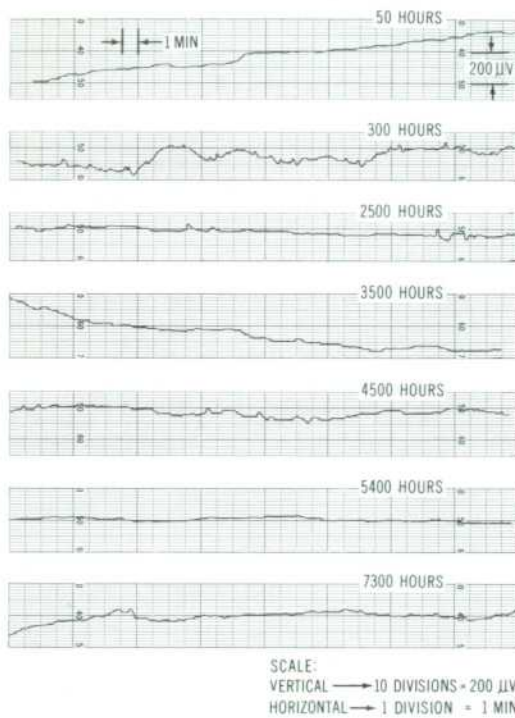

Fig. 4



LONG-TERM STABILITY OF THE -hp- 130C SENSITIVE DC-500 KC OSCILLOSCOPE

MAXIMUM gain, hence maximum sensitivity, in direct-coupled amplifiers is limited by drift. Drift is minimized by careful selection and utilization of components during the design of an amplifier but there remains an irreducible amount which arises primarily from leakage currents within the vacuum tubes of the first stage amplifiers. In oscilloscopes, this has meant that the maximum practical sensitivity is in the order of a hundred microvolts per centimeter.

The gradual deterioration of dc stability during the life of an amplifier, however, is an often encountered problem. Long-term tests are required to explore the possibility of this occurrence in new instruments.

As part of such a program, two

of the -hp- Model 130C high-sensitivity, dc-500 kc Oscilloscopes* have been kept in continuous operation for a period of more than 7,000 hours. This represents three to four years of normal operation and is thus indicative of the long-term behavior of the amplifiers in the 130C.

* John Strathman, "A DC-500 KC Oscilloscope with Extended Measurement Capabilities," *Hewlett-Packard Journal*, Vol. 13, No. 12, Aug., 1962.

The oscilloscopes were operated on non-regulated line voltage in a laboratory environment and were subject to the occasional vibration and minor mechanical shocks encountered during normal laboratory activities. The deflection plate outputs of both of the amplifiers in each oscilloscope were monitored
(concluded on next page)



-hp- Model 130C Oscilloscope has a basic sensitivity of 200 μ v/cm and an operating range from dc to beyond 500 kc.

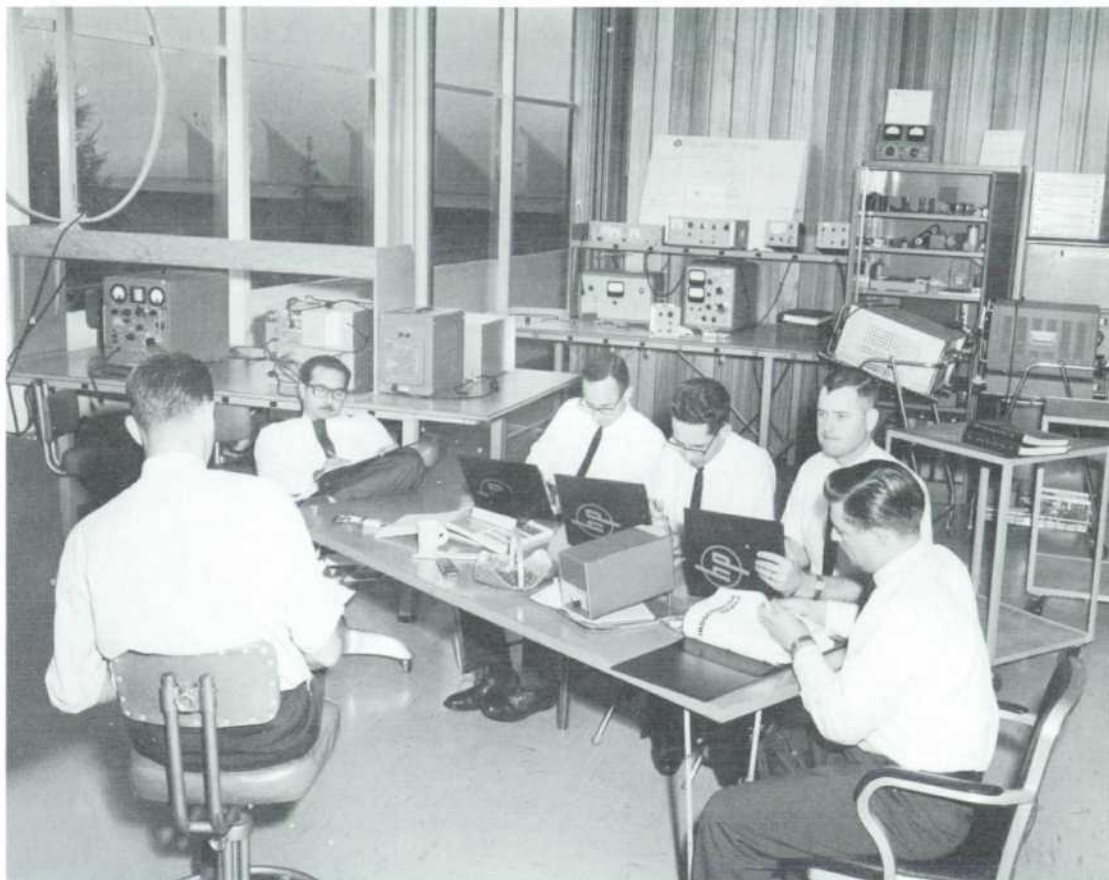

Customer Training Department seminar being conducted by -hp- instructor George C. Stanley. Training is given on calibration and maintenance of specific -hp- instruments.

-hp- FACTORY TRAINING SEMINARS

Instrument maintenance and service personnel may receive factory training on -hp- instruments throughout the year both in the field and at the Hewlett-Packard Palo Alto headquarters. Factory training seminars, which last for periods anywhere from one day to several weeks, teach the theory of selected groups of the -hp- family of instruments in addition to providing information on their maintenance, repair, and calibration. Instrument applications and measurement techniques are also covered in some of the

sessions. There is no charge for this training but arrangements must be made in advance through your local -hp- field engineer.

The seminars are conducted by experienced full-time instructors. The choice of topics and the locality of the presentations are adjusted to suit requests from the field. For further information on this service, please contact your -hp- field engineer who has full information on current schedules. He also is able to pass along suggestions for sessions on particular topics.