



Time Interval Measurements with the -hp- Electronic Counter

THE recently-introduced -hp- Model 522B Electronic Counter¹ measures such quantities as frequency, period, total events, and frequency ratio. Of special interest, however, are the applications in which the instrument is being used to measure time intervals.

A device that makes accurate, high-speed time interval measurements is an important tool for investigating many phenomena, both electrical and mechanical, such as:

- Stability
- Pulse duration
- Pulse interval
- Phase delay
- Velocity, linear and rotational
- Flow
- Distance (in terms of time)
- Photographic device operating times
- Relay operating times

Viscosity

Timing of many kinds of high-speed mechanical motion

For measuring time intervals, the 522B is arranged with two special terminals. One of these accepts a "start" signal, the other a "stop" signal. The purpose of these terminals is to open and close an electronic gate in the instrument. When the gate is open, a standard frequency from an internal precision oscillator and time base circuits is applied (Fig. 2) to the instrument's counter circuits. The counters thus measure the number of cycles of the time base circuits that the gate has been open, i.e., the time between the start and stop signals.

The precision oscillator is arranged with associated circuitry so that it makes available to the counters any one of six frequencies spaced in decade steps from 1 cps to 100 kcs. The counters will thus measure the time interval between the start and stop signals directly in units as short as 10 microseconds or as long as 1 second. The 5-place display system in the instrument permits up to 100,000 of any of these units to be measured. The total time-interval measuring capability of the instrument therefore ranges from a minimum of 10 micro-

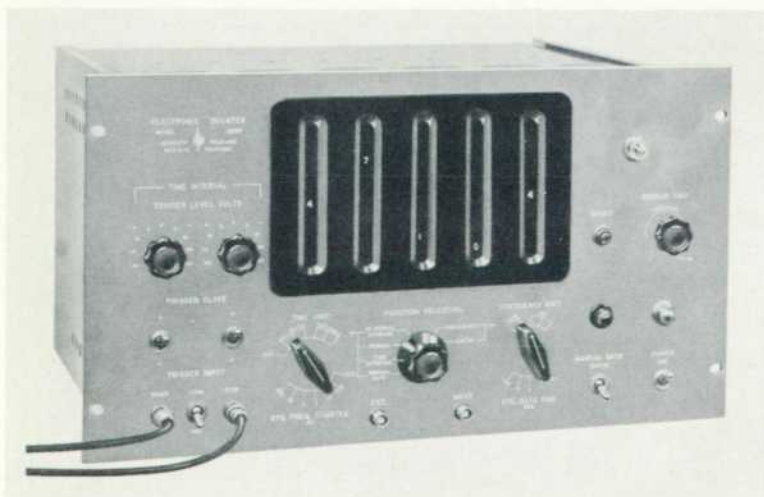

Fig. 1. Time interval-measuring ability of -hp- 522B Electronic Counter simplifies many measurements of electrical and mechanical phenomena. Instrument will also measure frequencies up to 100 kc, periods (1/f) as long as 100,000 seconds. Measurements presented on direct-reading digital system.

¹E. A. Hilton, "A New 100 KC Counter for Use in Electronics and Industry," Hewlett-Packard Journal, Vol. 4, No. 3, November 1952. Copies available upon request.

seconds to a maximum of 100,000 seconds (27.8 hours).

Use of the 522B in making studies of high-speed mechanical motion is typified by the application indicated in Fig. 3. Here, it was desired to have a shaft turn a discrete fraction of a rotation in an accurately-determined time of 1/7 second after the occurrence of the actuating signal. In addition, the system was to be capable of at least five such complete operations per second.

To rotate the shaft, the operating signal was amplified and caused to operate a solenoid as illustrated. The solenoid operated a trip on a high-speed clutch which coupled the driven shaft to a continuously-rotating driving shaft. A stop arrangement disengaged the clutch and indexed the driven shaft accurately at the end of its rotation.

Difficulties encountered with the time stability of the system led to suspicion of the operation of the high-speed clutch. But, because of its speed of operation, methods were not available to investigate its operation. As a result, *hp*-engineers were invited to determine whether electronic methods could be applied in achieving a solution.

To measure the clutch operating time, the 522B was connected as shown in Fig. 4. The start signal was obtained by arranging a sensitive switch so that it was operated by the clutch trip. The stop signal was obtained by attaching to the driven shaft a disk with an arm that operated a second sensitive switch as the shaft reached its stop. Using the

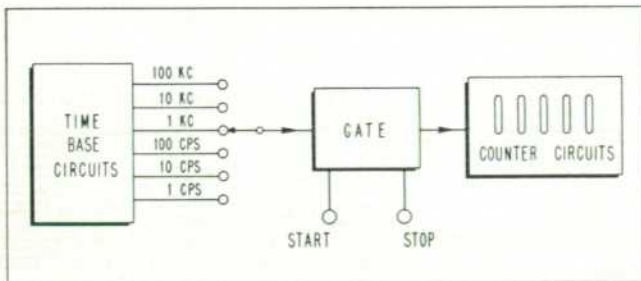

Fig. 2. Basic arrangement of *hp*-522B circuit when used to make time-interval measurements.

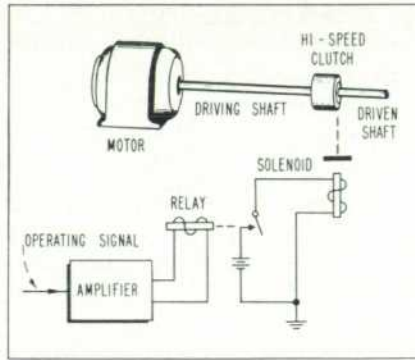

Fig. 3. Operating arrangement of high-speed clutch system.

522B with this arrangement it was quickly determined that the clutch system was indeed inaccurate, its operating time varying by a factor of more than 2 to 1.

To improve the clutch design, however, it was necessary to obtain more information concerning its operation throughout its nominal 1/7 second operating time. To accomplish this, a simple arrangement was devised whereby the disk could be clamped at any desired angular position on the driven shaft. The arm could thus have any desired relation to the shaft starting point. This arrangement permitted measurements to be made of the clutch operating time for any segment of the shaft rotation from the starting point. Besides allowing detailed studies of clutch performance as to engaging time, overrun, slippage, etc., this arrangement proved particularly convenient for making quick checks of the operation of various clutch designs.

RELAY MEASUREMENTS

The Model 522B can also be used to obtain detailed information on the operation of other high-speed devices such as relays. Information can be quickly obtained regarding such factors as the time interval re-

quired after energizing the relay coil for the relay arm to begin to move, the interval required for the arm to arrive at its "on" position, and the interval required for the arm to return to rest after the relay is de-energized. Studies can also be made of the variation in these times with applied voltage, temperature, etc.

Fig. 5 indicates an arrangement for measuring the time required for a relay arm to leave its rest position after the relay is energized. The start channel in the 522B is operated from the voltage rise across the relay winding, while the stop channel is operated from the voltage decay that occurs at "A" when the relay arm leaves its rest position. This time interval in a typical small relay was found to be 5.5 milliseconds.

Relay closing time can be measured by connecting the 522B stop channel to terminal "B" in Fig. 5, while return time can be measured with the arrangement in Fig. 5 by reversing the settings of the 522B trigger-slope panel switches, as described later. Typical values for closing time and return time in the above-mentioned relay were 8.1 and 18.8 milliseconds, respectively.

Because of their high reactance, circuits like those of Fig. 5 require certain precautions when making measurements. Any arcing at the switch as it closes and opens will result in undesired transients. These may not be revealed by a casual ex-

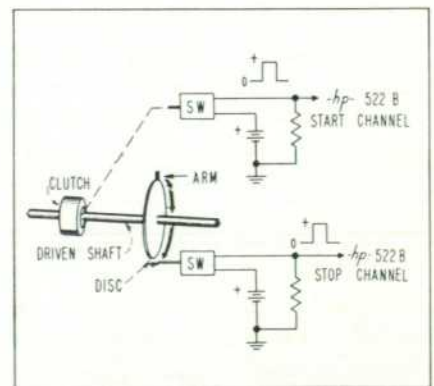

Fig. 4. Set-up used to investigate performance of high-speed clutch.

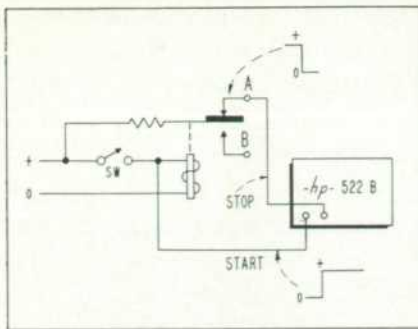

Fig. 5. Measurements of relay operating times are readily made with arrangements like this. Precautions are usually required to minimize switch arcing.

amination of the various waveshapes on an oscilloscope but will usually be revealed through use of the 522B. For example, if switch SW arcs on the make, the relay inductance will resonate with the capacity in the circuit to cause high-speed transients. These may appear at terminal A, and, if so, will act as a stop signal. Although the measurement made by the 522B will be accurate, it will not be a measurement of the desired interval.

To avoid arcing when the circuit is energized, an electronic switch can be used or, if it is desired to simulate an actual set-up, a mechanical switch with minimal arcing such as a mercury tumbler can be used. Arcing on the break is generally greater than on the make and may also interfere with the measurements. The effect of this arcing can be minimized by connecting across the relay winding a rectifier to damp the transients.

Most relays exhibit some bounce at the make contact. The 522B will make measurements to the first significant voltage rise occurring from bounce. In some cases, this rise may not be the desired start or stop signal so that consideration must be given to this factor.

THRESHOLD CONTROLS

As a convenience in making time interval measurements, the -hp-522B is provided with special threshold-selecting controls. These adjust the start and stop channels so that they will be actuated only by signals

of pre-determined polarity and amplitude. Two sets of the controls are provided to permit each channel to be operated by separate waveforms. Each set consists of a trigger slope switch and a trigger level control.

The trigger slope switch prepares the channel to trigger only from the positive or only from the negative slopes of the signal waveform. The voltage at which the channel will trigger is then selected by the trigger level control which is calibrated from +100 to -100 volts. The two controls thus permit each channel to be triggered from any one of four combinations of slope and polarity: positive or negative slopes of positive voltages, and positive or negative slopes of negative voltages. For each of these combinations the voltage level at which triggering occurs is adjustable from 0 to 100 volts.

The flexibility that the threshold controls give to the choice of starting and stopping points for the measurements is indicated on the waveforms illustrated in Fig. 6. If the start channel were to be operated from waveform "A", for example, the threshold controls would allow triggering from any point in any one of the four regions A through D indicated in the figure. In an actual application, of course, the choice as to which region and which point should be used for triggering would be dictated by the requirements of the application.

The stop channel can be adjusted in a similar manner. If the stop channel were to be operated from waveform "B" in Fig. 6, for exam-

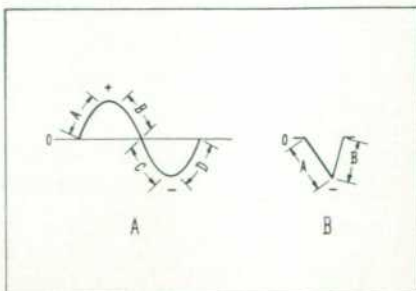

Fig. 6. -hp-522B threshold controls permit measurements to be started and stopped at any point in regions shown.

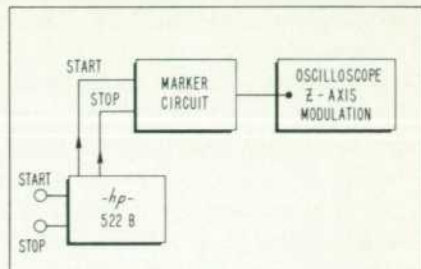

Fig. 7. Marker circuit and oscilloscope can be used with -hp-522B to obtain visual indication of start and stop points.

ple, either slope A or slope B could be selected with the stop channel slope switch. The triggering point on the slope would be determined by the stop channel level control.

A special switch is also provided so that the start and stop channels can be operated from the same input, if desired. The slope and level controls for each channel still remain operative, permitting measurements to be started and stopped from different portions of the signal.

The input circuits of the 522B are direct-coupled so that operation is not confined to waveshapes having fast rise times. The instrument can be used down to extremely low frequencies.

MARKER CIRCUITS

The +100 volt to -100 volt calibrations on the trigger level controls are approximate voltage calibrations which serve as a guide in making time interval measurements. When the waveforms involved are complicated, however, or whenever it is desired to have a positive visual indication of the points on the waveform at which the 522B is starting and stopping its measurement, a marker generator circuit can be built up externally and connected into the instrument.

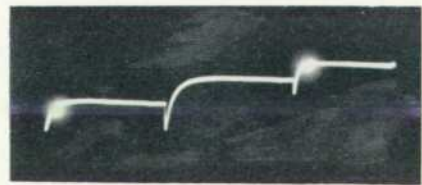

Fig. 8. Oscillogram showing visual presentation of start and stop points on complicated waveform.

To use a marker circuit, the 522B is arranged in a set-up like that of Fig. 7. The waveform under measurement is connected both to the 522B and to the vertical deflection system of an oscilloscope. The marker circuit is inserted between the 522B and the Z-axis modulation terminal on the oscilloscope.

A typical oscilloscope presentation obtained using a marker circuit is shown in Fig. 8. The first bright spot indicates the point at which the 522B starts its time-interval measurement. The second spot is the stopping point.

The marker circuit used for the oscillogram is shown in Fig. 9. This circuit generates two negative pulses which are adjustable in length from a few microseconds to about 300 microseconds to accommodate various oscilloscope sweep speeds. An amplitude control permits the intensity of the marker spots to be adjusted.

PHASE DELAY MEASUREMENTS

Another application in which the time-interval feature of the 522B simplifies an otherwise inconvenient measurement is in measuring the phase delay in very low frequency devices such as servo amplifiers. Be-

cause of the ability of the 522B to measure extremely long time intervals of up to 100,000 seconds, phase delay measurements can be made of nearly any low-frequency system by measuring the elapsed time between the crossings of the zero axis by the original and delayed waves.

Typical low-frequency phase delay measurements can be made with the set-up indicated in Fig. 10. To make this type of measurement, assuming that a sinusoidal waveform

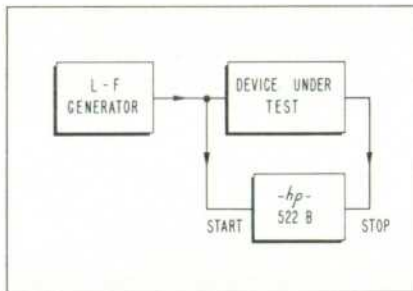

Fig. 10. Set-up for measuring phase delay at very low frequencies.

is involved, either of two techniques should be used to minimize errors arising from shifts in d-c levels and differences in amplitude. First, the threshold controls can be adjusted so that the readings obtained when triggering from the positive slopes

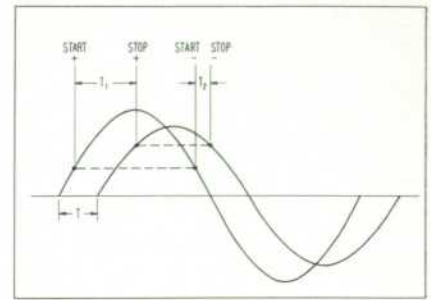

Fig. 11. Representation of time intervals measured when determining l-f phase delays.

of the undelayed and delayed waveforms are equal to the readings obtained when triggering from the negative slopes. The phase delay is then given in time units by the 522B reading.

The second technique usually becomes the quicker of the two techniques as the frequency involved becomes lower and lower. Referring to Fig. 11, a measurement is made of t_1 by setting the 522B slope switches to their positive positions and by setting the threshold controls to suitable positive values. A measurement of t_2 is then made by setting the slope switches to their negative positions without altering the settings of the threshold controls. The phase delay T is then equal to $(t_1 + t_2)/2$, the average of the two readings obtained on the 522B. This time value can then be easily converted into electrical degrees by use of the expression

$$\phi \text{ degrees} = \frac{T \times 360}{\text{Period}}$$

where period is the period of the frequency involved and T is the average of the two 522B readings.

When making measurements of this type, it is desirable that the threshold controls be set to a voltage which corresponds to the area of the measured wave that has highest slope. With sine waves this means that the controls be set near zero volts.

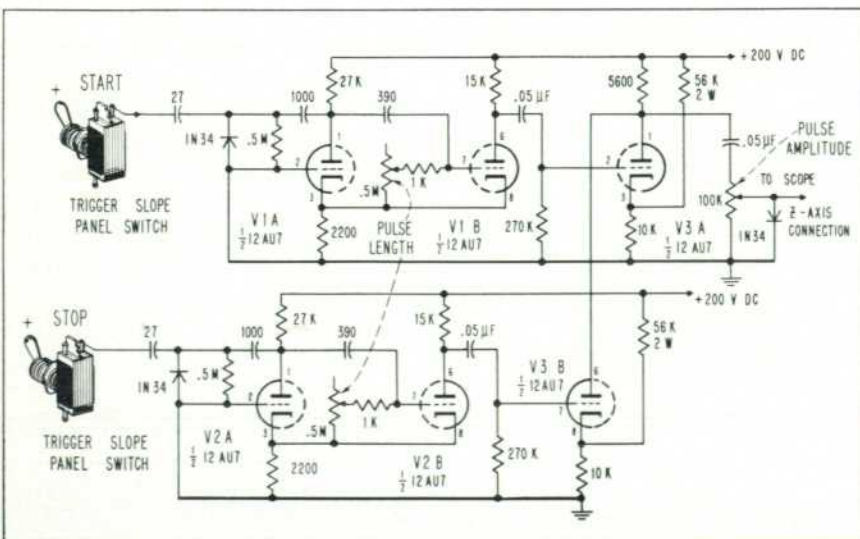

Fig. 9. External marker circuit used to obtain marker dots shown in Fig. 8. Diagram illustrates how external circuit should be connected to 522B slope switches.

—E. A. Hilton and
D. R. Scott