

# The 'Powerful Pocketful': an Electronic Calculator Challenges the Slide Rule

*This nine-ounce, battery-powered scientific calculator, small enough to fit in a shirt pocket, has logarithmic, trigonometric, and exponential functions and computes answers to 10 significant digits.*

**By Thomas M. Whitney, France Rodé, and Chung C. Tung**

**W**HEN AN ENGINEER OR SCIENTIST NEEDS A QUICK ANSWER to a problem that requires multiplication, division, or transcendental functions, he usually reaches for his ever-present slide rule. Before long, however, that faithful 'slip stick' may find itself retired. There's now an electronic pocket calculator that produces those answers more easily, more quickly, and much more accurately.

Despite its small size, the new HP-35 is a powerful scientific calculator. The initial goals set for its design were to build a shirt-pocket-sized scientific calculator with four-hour operation from rechargeable batteries at a cost any laboratory and many individuals could easily justify. The resulting nine-ounce product surprises even many who are acquainted with what today's large-scale integrated circuits can achieve.

The HP-35 has basically the same functions and accuracy of other HP calculators, and it is portable. It is a close cousin to the many four-function electronic calculators which have appeared in recent years, initially from Japan and now from many U.S. manufacturers. However, three features set the HP-35 apart from four-function calculators. First, none of the four-function calculators has

transcendental functions (that is, trigonometric, logarithmic, exponential) or even square root. Second, the HP-35 has a full two-hundred-decade range, allowing numbers from  $10^{-99}$  to  $9.999999999 \times 10^{99}$

to be represented in scientific notation. Third, the HP-35 has five registers for storing constants and results instead of just one or two, and four of these registers are arranged to form an operational stack, a feature found in some computers but rarely in calculators (see box, page 5). On page 7 are a few examples of the complex problems that can be solved with the HP-35.

## Data Entry

The photograph of the calculator on this page shows how the keys are arranged. Numbers enter the display, which is also called the X register, from left to right exactly as the keys are pressed. Entry is entirely free-field, that is, digits will be displayed exactly as they are entered, including leading or trailing zeros.

The enter-exponent key, EEX, is used for entering numbers in scientific notation. For example,

the number 612,000 may be entered as 6.12 EEX 5 or 612 EEX 3 or .0612 EEX 7 as well as 612000. The change-sign key, CHS, changes the sign of the man-



tissa or, if pressed immediately following EEX, the sign of the exponent. Mistakes during data entry can be corrected by use of the clear x key, CLx. A special key is provided for entering  $\pi$ .

**Display**

The display consists of 15 seven-segment-plus-decimal-point light-emitting-diode (LED) numerals. Answers between  $10^{10}$  and  $10^{-2}$  will always be displayed as floating-point numbers with the decimal point properly located and the exponent field blank. Outside this range the HP-35 displays the answer in scientific notation with the decimal point to the right of the first significant digit and the proper power of 10 showing at the far right of the display. To make the display more readable, a separate digit position is provided for the decimal point.

The display is always left justified with trailing zeros suppressed. For instance, the answer to  $3 \div 4$  appears as .75 instead of 0.75000000.

Answers greater than  $10^{100}$  (overflow) are displayed as  $9.99999999 \times 10^{99}$ , and answers smaller than  $10^{-99}$  are returned as zeros. These are the HP-35's 'closest' answers. Improper operations, such as division by zero or the square root of a negative number, cause a blinking zero to appear.

**Single-Operand Function Keys**

The function keys operate on the number displayed in the X register, replacing it with the function of that argument. The trigonometric functions, sin, cos, tan, arc sin, arc cos, and arc tan operate in degrees only. For inverse trigonometric functions the function key is preceded by the arc key. The angle obtained will be the principal value.

The functions log x and ln x compute the logarithm of x to base 10 and base e respectively. The exponential function  $e^x$  is also provided. Other single-operand functions are the square root of x,  $\sqrt{x}$ , and the reciprocal of x,  $1/x$ .

**Arithmetic Keys: Two-Operand Functions**

The arithmetic functions, +, -,  $\times$ , and  $\div$ , and the power function  $x^y$ , operate on the X and Y registers, with the answer appearing in X. Numbers are copied from X into Y by use of the ENTER $\uparrow$  key. Thus to raise 2 to the 7th power the key sequence is 7, ENTER $\uparrow$ , 2,  $x^y$  and the answer 128 is displayed immediately after  $x^y$  is pressed. This is a general principle: when a key is pressed, the corresponding operation is performed immediately.

Although raising x to a power can be accomplished via the formula  $x^y = e^{y \ln x}$  and in fact is done this way internally, the single-keystroke operation is much more convenient. The power, y, can be any positive or negative integer or fraction, while x must be positive.

**Registers and Control Keys**

Five registers are available to the user. Four of these, called X, Y, Z, and T, form an operational stack. The fifth, S, is for constant storage. (For clarity, capital letters refer to the registers and lower-case letters refer to the contents of the registers.)

Five keys are used to transfer data between registers. The ENTER $\uparrow$  key pushes the stack up, that is, x is copied into Y, y into Z, z into T, and t is lost. This key is used as a separator between consecutive data entries, such as in the power example just described. Roll down, R $\downarrow$ , is used to view the contents of X, Y, Z, and T. Four consecutive operations of this key return the registers to the original state with no loss of data.



**Cover:** Our thanks to Dr. Dennis R. Clark of the Stanford University Department of Pharmacology for allowing us to photograph him at work with his HP-35 Pocket Calculator.

**In this Issue:**

*The 'Powerful Pockettful': an Electronic Calculator Challenges the Slide Rule*, by Thomas M. Whitney, France Rodé, and Chung C. Tung . . . . . **page 2**

*Algorithms and Accuracy in the HP-35*, by David S. Cochran . . . . . **page 10**

*Packaging the Pocket Calculator*, by Edward T. Liljenwall . . . . . **page 12**

*New Capabilities in Digital Low-Frequency Spectrum Analysis*, by Stephan G. Cline and Norman D. Marschke . . . . . **page 14**

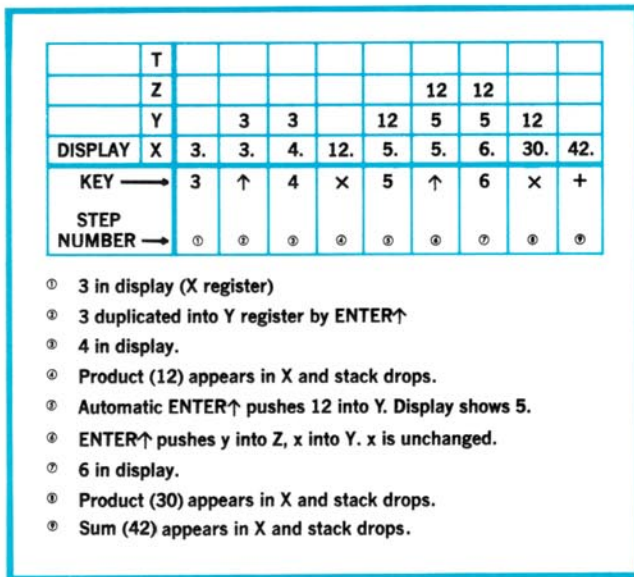

**Fig. 1.** HP-35 Pocket Calculator has a four-register operational stack (last-in-first-out memory). Here's how the stack works to solve  $(3 \times 4) + (5 \times 6)$ . Answers appear in display register X, in floating-point or scientific notation, to 10 significant digits.

The contents of X and Y can be exchanged using  $\leftrightarrow$ ; this is useful if the operands have been entered in the improper order for  $x^y$ ,  $-$ , or  $\div$ . The constant storage location, S, is accessed via the two keys store, STO, and recall, RCL.

The operational stack is automatically pushed up for data entries following any operation other than ENTER↑, STO, and CLx. This saves many uses of the ENTER↑ key. The stack automatically drops down following any two-operand function (+, -, ×, ÷,  $x^y$ ). For example, to do the problem  $(3 \times 4) + (5 \times 6)$  the key sequence is: 3, ENTER↑, 4, ×, 5, ENTER↑, 6, ×, + (see Fig. 1). ENTER↑ is unnecessary between × and 5 because the answer to the first term, 12, is automatically transferred to Y when the 5 is entered. Also, no R↓ is necessary after the second × since the first term, 12, is automatically transferred from Z to Y after the multiplication.

The clear-all key, CLR, clears all registers including storage. Initial turn-on of the calculator has the same effect.

On the back of the calculator is an instruction panel that provides the user with quick answers to the most commonly asked 'how-to-do-it' questions (Fig. 2). The panel also shows an example of a problem solution.

### System Organization

Now let's go inside and see what makes it work. The HP-35 contains five MOS/LSI (metal-oxide-

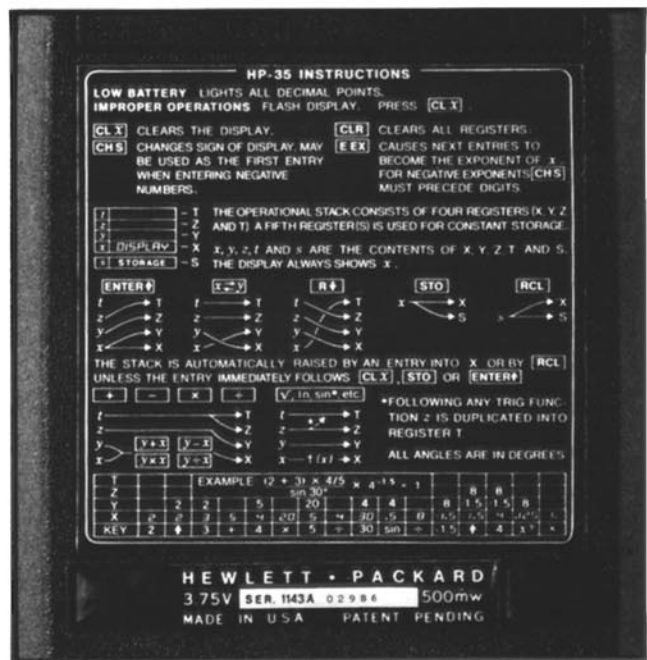

**Fig. 2.** Instruction panel on back of calculator answers most frequently asked questions.

semiconductor/large-scale-integration) circuits: three read-only-memories (ROMs), an arithmetic and register circuit (A&R), and a control and timing circuit (C&T). The logic design was done by HP and the circuits were developed and manufactured by two outside vendors. Three custom bipolar circuits are manufactured by HP's Santa Clara Division: a two-phase clock driver, an LED anode driver/clock generator, and an LED cathode driver. Fig. 3 is a block diagram of the calculator.

The HP-35 is assembled on two printed circuit boards (see Fig. 4). The upper board contains the display and drivers and the keyboard. The lower and smaller board has all the MOS logic, the clock driver, and the power supply.

The calculator is organized on a digit-serial, bit-serial basis. This organization minimizes the number of connections on each chip and between chips, thereby saving area and cost and improving reliability. Each word consists of 14 binary-coded-decimal digits, so each word is 56 bits long. Ten of the 14 digits are allocated to the mantissa, one to the mantissa sign, two to the exponent, and one to the exponent sign.

Three main bus lines connect the MOS circuits. One carries a word synchronization signal (SYNC) generated by a 56-state counter on the control and timing chip. On another bus, instructions ( $I_s$ ) are transmitted serially from the ROMs to the control and timing chip or to the arithmetic and register

## Operational Stacks and Reverse Polish Notation

In 1951, Jan Lukasiewicz' book on formal logic first demonstrated that arbitrary expressions could be specified unambiguously without parentheses by placing operators immediately before or after their operands. For example, the expression

$$(a + b) \times (c - d)$$

is specified in operator prefix notation as

$$\times + ab - cd$$

which may be read as multiply the sum a plus b by the difference c minus d. Similarly, the expression can be specified in operator postfix notation as

$$ab + cd - \times$$

with the same meaning. In honor of Lukasiewicz, prefix and postfix notation became widely known as Polish and reverse Polish, respectively.

During the following decade the merits of reverse Polish notation were studied and two simplifications in the execution of computer arithmetic were discovered. First, as reverse Polish notation is scanned from left to right, every operator that is encountered may be executed immediately. This is in contrast to notation with parentheses where the execution of operators must be delayed. In the above example,  $(a + b) \times (c - d)$ , the multiply must wait until  $(c - d)$  is evaluated. This requires additional memory and bookkeeping. Second, if a stack (that is, a last-in-first-out memory) is used to store operands as a reverse Polish expression is evaluated, the operands that an operator requires are always at the bottom of the stack (last operands entered). For  $(a + b) \times (c - d)$ , the reverse Polish,  $ab + cd - \times$ , is evaluated as follows.

	T							
	Z					a + b		
	Y	a		a + b	c	a + b		
↑ stack	X	a	b	a + b	c	d	c - d	(a + b) × (c - d)
Reverse Polish		Enter a	Enter b	+	Enter c	Enter d	-	×

These properties have made the notation a valuable tool in the computer industry. All modern computer compilers for languages such as FORTRAN and ALGOL convert statements to reverse Polish in some form before producing a program that can be executed. Some computer manufacturers have even designed their machines with special instructions to perform stack operations to facilitate execution of reverse Polish. However, the HP-35 is the first scientific calculator to fully exploit the advantages of reverse Polish and automatic stack operations to provide user convenience seldom found in calculators.

chip. The third bus signal, called word select (WS), is a gating signal generated on the C&T chip or by the ROMs; it enables the arithmetic unit for a portion of a word time, thereby allowing operations on only part of a number, such as the mantissa or the exponent.

### Control and Timing Circuit

The control and timing (C&T) circuit performs the major nonarithmetic, or housekeeping functions in the calculator. These include interrogating the keyboard, keeping track of the status of the system, synchronizing the system, and modifying instruction addresses.

The keyboard is arranged as a five-column, eight-row matrix. It is scanned continuously by the C&T chip. When contact is made between a row and a column by pressing a key, a code corresponding to that row and column is transmitted over the I<sub>A</sub> line to the read-only memory (ROM). This code is the starting address of a program in ROM to service that key. Key bounce and lockout are handled by programmed delays.

In all digital systems, status bits or flags are used to keep track of past events. In the HP-35 there are twelve status bits, all located on the C&T chip. They can be set, reset, or interrogated by microinstructions.

ROM addresses are updated on the C&T chip and sent serially to the ROMs over the I<sub>A</sub> bus. During execution of a branch instruction, the appropriate signal—arithmetic carry or status bit—is tested to determine whether the incremented address or the branch address should be selected next.

A powerful feature of the serial organization is the ability to operate on just a single digit of a number as it flows through the arithmetic unit. On the C&T chip are a pointer register and a word-select circuit which issue a word-select signal (WS) corresponding to the time slot being operated upon. The value of the pointer register can be set, incremented, and decremented by microinstructions.

### Read-Only Memory

Preprogrammed mathematical routines are stored in three ROM chips, each of which contains 256 instructions of 10 bits each. A specific select code is assigned to each ROM chip. Only one of the three ROM chips is used at any time. When a ROM selection instruction is issued, a decoder inside each ROM checks the select-code field of the instruction. In case of a match, the selected ROM turns on. Unselected ROMs turn off.

A timing circuit on each ROM is synchronized to the SYNC signal issued by the C&T chip as the calculator is turned on. This circuit then keeps the ROM chip running synchronously with the rest of the system.

A ROM address register on each ROM chip receives the address sent out by the C&T chip. The corresponding instruction is placed on the instruc-

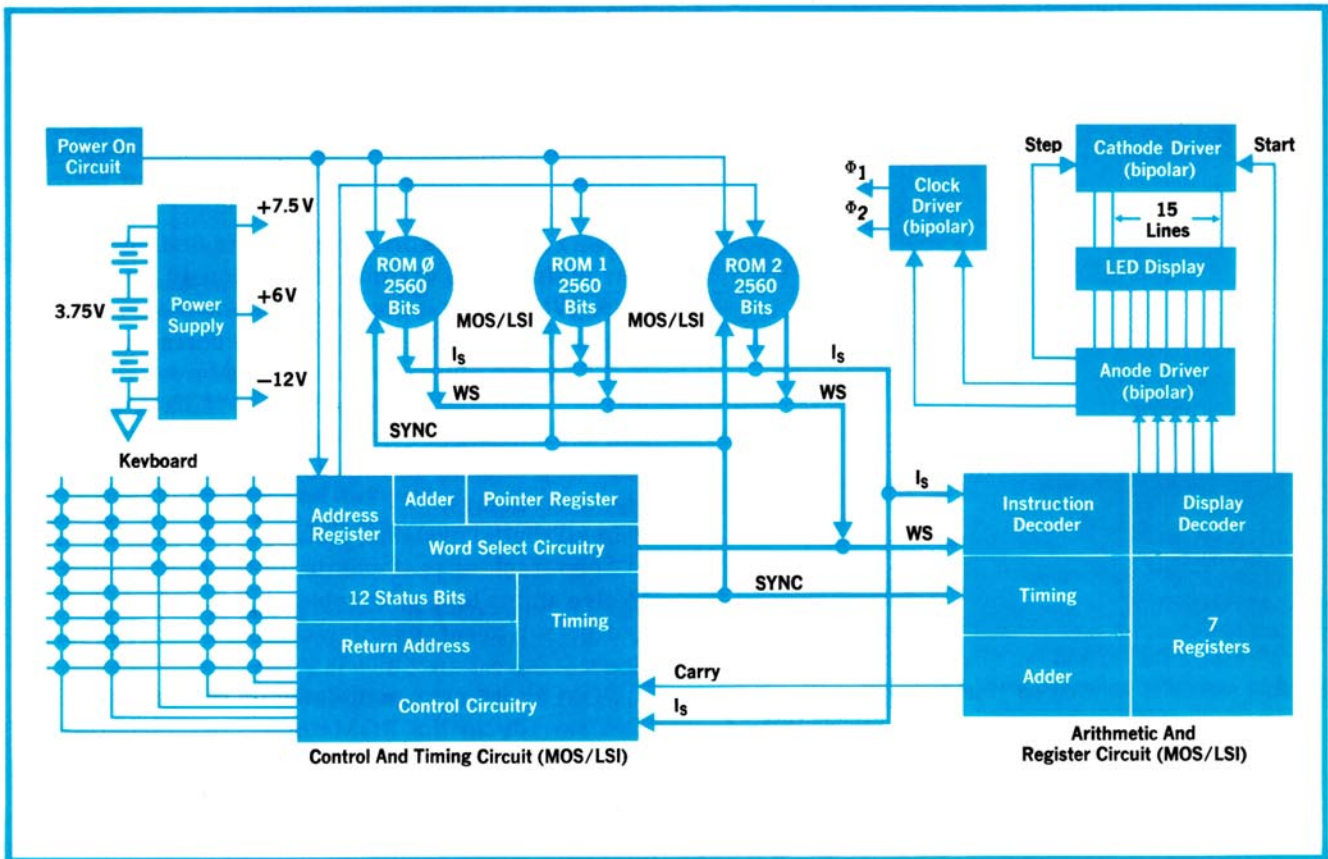

**Fig. 3.** Five MOS/LSI circuits, developed by HP, are manufactured by outside vendors. Three custom HP-developed bipolar IC's are manufactured by HP. SYNC,  $I_s$ , and WS are three main bus lines connecting the MOS circuits.

tion line,  $I_s$ , provided the ROM chip is turned on.

The ROM chip also issues word-select signals for certain classes of instructions.

#### Arithmetic and Register Circuit

The arithmetic and register circuit executes instructions coming in bit-serially on the  $I_s$  line. Most arithmetic instructions must be enabled by WS, the word-select signal. Data to be displayed is sent to the LED anode drivers on five lines, and one carry line transfers carry information back to the C&T chip. The BCD output is bidirectional and can carry digits into and out of the A&R chip.

The A&R circuit is divided into five areas: instruction storage and decoding circuits, a timing circuit, seven 56-bit registers, an adder-subtractor, and a display decoder.

Three of the registers are working registers. One of these and three of the remaining four registers form the four-register stack. The seventh register is an independent register for constant storage. There are numerous interconnections between registers to allow for such instructions as exchange,

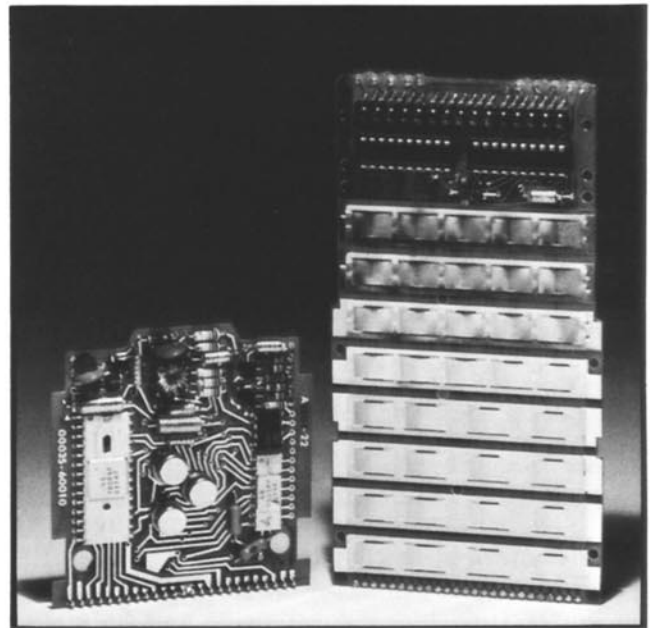
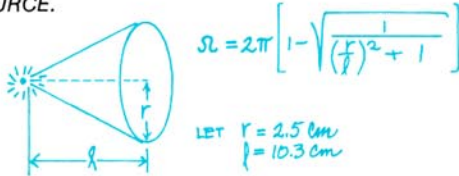

**Fig. 4.** Two printed-circuit boards contain all circuits. Metal humps on the larger board are pressed down by the keys to make contact with printed traces underneath.

## How the HP-35 Compares with the Slide Rule

These comparisons were made by engineers who are not only highly proficient in slide rule calculation, but were also familiar with the operation of the HP-35. Thus, the solution times should not be taken as typical. They do, however, serve to indicate the relative time advantage of the HP-35 and to point up the still more significant advantage of its accuracy.

**PROBLEM 1: COLLECTION SOLID ANGLE FROM A POINT SOURCE.**



**HP-35 SOLUTION:**

2.5  $\div$  10.3  $\div$  1  $\div$   $\sqrt{\square}$   $\div$  1  $\div$  2  $\times$   $\pi$   $\rightarrow$  .1772825509

**SLIDE RULE SOLUTION:** .176

**TIME ON HP-35:** 20 seconds with answer to ten significant digits.

**TIME ON SLIDE RULE:** 3 minutes, 15 seconds with answer to three decimal places.

**PROBLEM 2: GREAT CIRCLE DISTANCE BETWEEN SAN FRANCISCO AND MIAMI.**

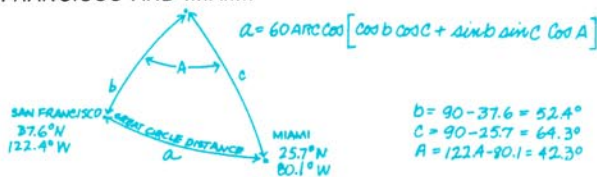

transfer, rotate stack, and so on. An advantage of the bit-serial structure is that interconnections require only one gate per line.

Transfers into or out of the stack or the constant register are always whole-word transfers. All other arithmetic instructions are controlled by the word select signal, WS. Thus it's possible to interchange only the exponent fields of two registers, or to add any two corresponding digits of two registers.

The adder-subtractor computes the sum or difference of two decimal numbers. It has two data inputs, storage for carry or borrow, and sum and carry/borrow outputs. For the first three clock times, the addition is strictly binary. At the fourth clock time the binary sum is checked, and if the answer is more than 1001 (nine), then the sum is corrected to decimal by adding 0110 (six). The result is then entered into the last four bits of the receiving register and the carry is stored. A similar correction is done for subtraction. Carry information is always transmitted, but is recorded by the control and timing chip only at the last bit time of the word-select signal.

**HP-35 SOLUTION:**

52.4  $\cos$  64.3  $\cos$   $\times$  52.4  $\sin$  64.3  $\sin$   $\times$  42.3  $\cos$   $\div$   $\sqrt{\square}$   $\div$  60  $\times$   $\rightarrow$  2254.093016

**SLIDE RULE SOLUTION:** 2255 mm.

**TIME ON HP-35:** 65 seconds with answer to ten significant digits.

**TIME ON SLIDE RULE:** 5 minutes with answer to four significant digits.

**PROBLEM 3: pH OF A BUFFER SOLUTION.**

$$\alpha_H = 1 + \sum C_0 K_a, \quad H^+ = \sqrt{\frac{1}{\alpha_H} \sum \frac{C_a}{K_a}}$$

FOR A MIXTURE OF  $\text{Na}_2\text{HPO}_4$  @  $0.3 \text{ M/l}$  AND  $\text{NaH}_2\text{PO}_4$  @  $8.7 \times 10^{-3} \text{ M/l}$

$$\alpha_H = 1 + [3 \times 10^{-2}] (10^{7.2}) + [8.7 \times 10^{-3}] (10^{2.16})$$

$$-H^+ = \log \sqrt{\frac{1}{\alpha_H} \left( \frac{3 \times 10^{-2}}{10^{11.7}} + \frac{8.7 \times 10^{-3}}{10^{7.34}} \right)}$$

**HP-35 SOLUTION:**

7.21  $\div$  10  $\times$  .03  $\times$  1  $\div$  2.16  $\div$  10  $\times$  .0087  $\div$   $\sqrt{\square}$   $\div$   $\log$   $\rightarrow$  .03  $\div$

11.7  $\div$  10  $\times$  .0087  $\div$  7.21  $\div$  10  $\times$   $\div$   $\sqrt{\square}$   $\div$   $\log$   $\rightarrow$

$-7.47877778$

**SLIDE RULE SOLUTION:** 7.43

**TIME ON HP-35:** 65 seconds with answer to ten significant digits.

**TIME ON SLIDE RULE:** 5 minutes with answer to three significant digits.

## Simulation and Test of the MOS Circuits

In designing elaborate integrated circuits like the C&T, A&R, and ROM chips, two questions that have to be answered at the very beginning are: How is the design to be checked? and How is the final integrated circuit to be tested?

The first question has two answers. One is to build a breadboard and compare its operation with the desired operation. A second answer is a computer simulation of the circuit. When the MOS circuits (C&T, A&R, and ROMs) for the HP-35 were being designed, the computer simulation approach was chosen over a TTL or MOS breadboard. It was felt that the hardware breadboard wouldn't be an exact model of the final circuits anyway, and two or three months of development time could be saved by computer simulation because people could work in parallel rather than serially on a breadboard.

A general-purpose simulation program, HP-DABEL, had just been developed by Jim Duley of HP Laboratories. This was used to check out each gate, each circuit, each chip, and finally all the chips together. Each MOS circuit is designed as a network

of gates and delay elements. For each gate output an algebraic equation was written as function of the inputs to the gate. This produced a large set of algebraic equations to be evaluated every clock time. A printout was available so the operation of any of the gates or delay outputs could be observed, as if with an oscilloscope probe. In this respect the computer simulation was much better than a hardware breadboard.

Because of the large number of equations to be evaluated each clock time the general-purpose simulation program was too slow to use for evaluating the algorithms implemented in the ROMs. For this a higher-level simulation was used, so only the input/output functions of each subsystem had to be specified. This was fast enough that all the algorithms could be checked, even the transcendental functions. If anything went wrong it was always possible to stop the program and step through it until the trouble was found. Correcting a problem was a simple matter of changing a punched card or two. These are advantages a hardware breadboard doesn't have.

The simulation approach proved very successful. It saved a lot of time not only in logic design, but also in generating the test patterns to be used for testing the final integrated circuits. After a simulation is running successfully a pattern for each input is specified such that virtually every circuit element will be exercised. By running the program and recording all the inputs and outputs a complete test pattern is generated. This is recorded on tape, ready for final test of the IC.

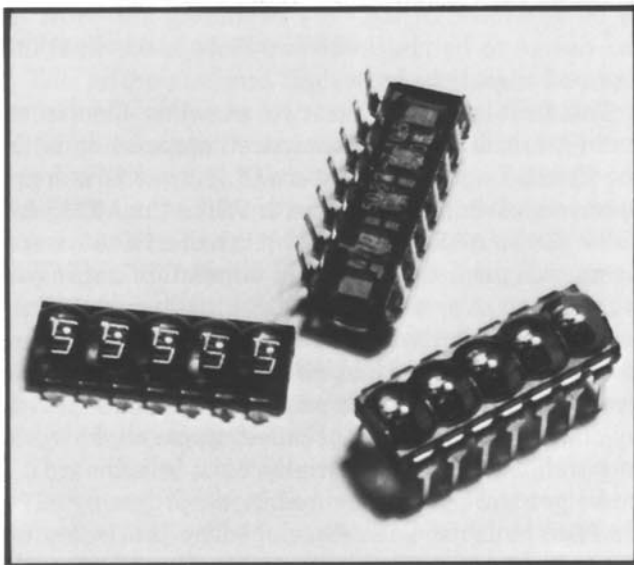

**Fig. 5.** Light-emitting-diode cluster was specially developed for the HP-35. Magnifying lenses are built in.

## Display and Drivers

It was apparent early in the HP-35 planning that new display techniques would be required. Existing light-emitting-diode products used too much power and cost too much. HP Associates developed a magnified five-digit cluster which saves both power and cost and is packaged in a convenient 14-pin package (Fig. 5). Each digit has a spherical lens molded in the plastic over it. A slight reduction in viewing angle results, but for the handheld calculator this is not a problem.

LED's are more efficient if they are pulsed at a low duty cycle rather than driven by a dc source. In the HP-35, energy is stored in inductors and dumped into the light-emitting diodes. This drive technique allows a high degree of multiplexing; the digits are scanned one at a time, one segment at a time.

Customized bipolar anode and cathode driver circuits incorporating the required features were developed and are manufactured by HP. The anode driver generates the two-phase system clock and the segment (anode) drive signals, decodes the data from the arithmetic and register chip and inserts the decimal point, sends shift signals to the other axis of the multiplex circuitry (the cathode driver), and senses low battery voltage to turn on all decimal points as a warning that about 15 minutes of operating time remains. The cathode driver contains a 15-position shift register which is incremented for each digit position.

## Keyboard

Requirements for the HP-35's keyboard were particularly difficult. The keyboard had to be reliable, inexpensive, and low-profile, and have a good 'feel'. The solution is based on the 'oilcan' or 'cricket' principle, that is, curved metal restrained at the edges can have two stable states. The larger board in Fig. 4 shows the etched metal keyboard strips running horizontally. At each key location the metal is raised to form a hump over a printed-circuit trace running underneath. Depressing a key snaps the metal down to make contact with the trace. The keys have a definite 'fall-away' or 'over-center' feel so that there is no question when electrical contact is complete.

## Acknowledgments

The many people who contributed to the HP-35 did so with great energy and enthusiasm. There was a feeling throughout the project that we had a tremendous winner. Appreciation is due the particularly important contributors below:

Tom Osborne for the initial product definition and continued guidance on what a calculator was and for whom it was intended.

Paul Stoft for providing technical direction and an environment where wild ideas can flourish and for keeping our unbounded optimism in check.

Dave Cochran for initial system design, algorithm selection, and sophisticated and clever microprogramming.

Chu Yen for a super-efficient power supply and work on the recharger/ac adaptor, with the able assistance of Glenn McGhee.

Ken Peterson for the automatic logic board tester and for devising novel methods to test the elusive dynamic MOS circuitry.

Rich Marconi and Charlie Hill for the design of the display board tester and to Rich for patience through many redesigns of the PC boards.

Bill Misson and Dick Osgood for an inexpensive, reliable and producible keyboard.

Clarence Studley and Bernie Musch for creative and durable packaging and for not yelling, 'There's no more room' too often.

Jim Duley, Margaret Marsden, and John Welsch for assistance in computer programs for test patterns, simulation, and microassemblers.

Ed Liljenwall for exceptionally creative industrial design work including the improbable result that 35 easily operated keys can exist in a three-by-five-inch area.

Tom Holden and Neil Honeychurch for providing a close liaison with the manufacturing division to speed the design of the fabricated parts.

And lastly to our behind-the-scenes project leader, Bill Hewlett, who initiated the project and kept the fires burning whenever needed. 📧



#### **Thomas M. Whitney**

Tom Whitney holds BS, MS, and PhD degrees in electrical engineering, all from Iowa State University, received in 1961, 1962, and 1964, respectively. With HP Laboratories since 1967, he has served as digital systems section leader and as section manager for the HP-35 Pocket Calculator. He's also a lecturer at Santa Clara University, currently teaching a course in microprogramming. Away from electronics, Tom spends as much time as possible outdoors, with skiing, tennis, and camping the major activities.

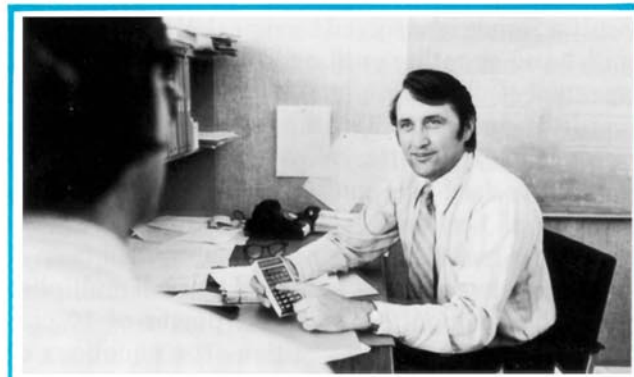

#### **France Rodé**

France Rodé came to HP in 1962, designed counter circuits for two years, then headed the group that developed the arithmetic unit of the 5360 Computing Counter. He left HP in 1969 to join a small new company, and in 1971 he came back to HP Laboratories. For the HP-35, he designed the arithmetic and register circuit and two of the special bipolar chips. France holds the degree Diploma Engineer from Ljubljana University in Yugoslavia. In 1962 he received the MSEE degree from Northwestern University. When he isn't designing logic circuits he likes to ski, play chess, or paint.

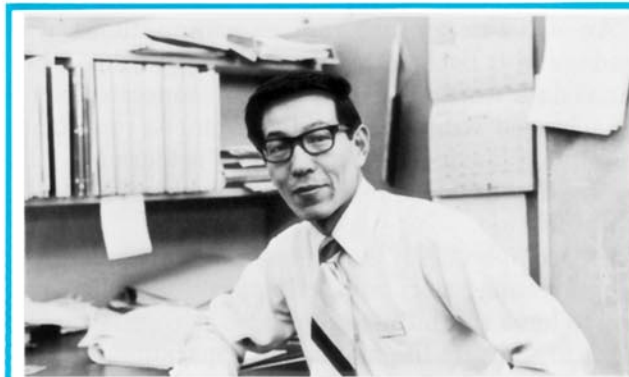

#### **Chung C. Tung**

Chung Tung received his BS degree in electrical engineering from National Taiwan University in 1961, and his MSEE degree from the University of California at Berkeley in 1965. Late in 1965 he joined HP Laboratories. He was involved in the design of the 9100A Calculator and was responsible for the design and development of two of the MOS/LSI circuits in the HP-35 Pocket Calculator: the control and timing chip and the read-only-memory chips. Now working for his PhD at Stanford University, Chung still manages to find time now and then to relax with swimming or table tennis.